

Design by Nahtrang Design

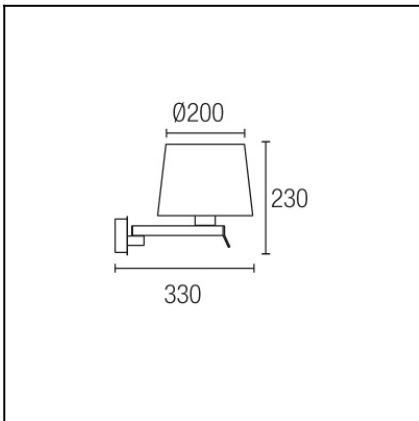

The photograph may not match the reference exactly. Please read the product description to identify the finish.



TECHNICAL CHARACTERISTICS

Type:	Wall fixture
Adjustable $\pm 120^\circ$ on the horizontal axis.	
IP Protection degrees:	IP20
Lampholder:	1 x E27
Power (W):	E27 60w
Total power consumption (W):	60
Voltage / Frequency:	220-240V/50-60Hz
Units per box:	8
Net Weight (Kg):	0.48
EAN:	8435111086674

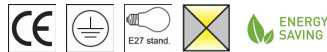

MATERIALS / FINISHES

Structure material: Steel
Structure finish: Old brown

[Download photometric file .ldt / .ies](#)

PAN-175-14

Structure material: Steel
Structure finish: White

Diffuser material: Fabric shade
Diffuser finish: White

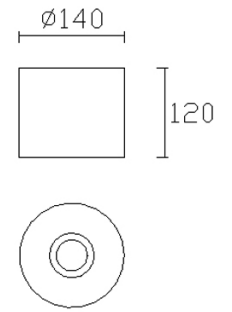

IP20

PAN-175-BY

Structure material: Steel
Structure finish: White

Diffuser material: Fabric shade
Diffuser finish: Sandblasted

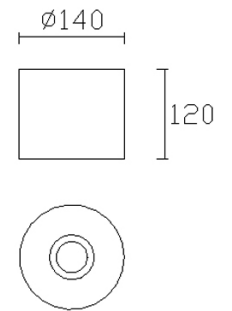

IP20

PAN-157-14

Structure material: Steel
Structure finish: White

Diffuser material: Fabric shade
Diffuser finish: White

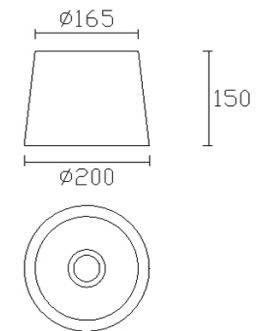

IP20

PAN-157-BY

Structure material: Steel
Structure finish: White

Diffuser material: Fabric shade
Diffuser finish: Sandblasted

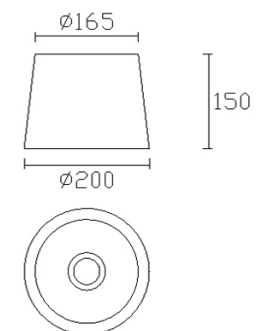

IP20

PAN-158-J6



Structure material: Steel
Structure finish: White

Diffuser material: Fabric shade
Diffuser finish: Brown

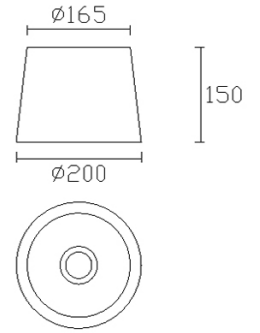

IP20

PAN-169-14



Structure material: Steel
Structure finish: White

Diffuser material: Fabric shade
Diffuser finish: White

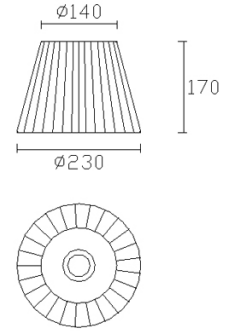

IP20

PAN-161-14



Structure material: Steel
Structure finish: White

Diffuser material: Fabric shade
Diffuser finish: White

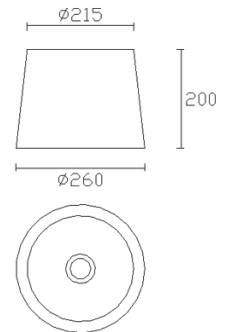

IP20

PAN-161-BY



Structure material: Steel
Structure finish: White

Diffuser material: Fabric shade
Diffuser finish: Sandblasted

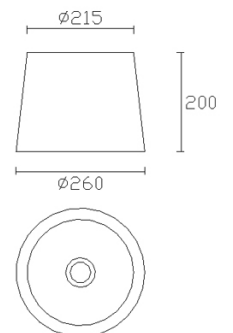

IP20

PAN-162-J6



Structure material: Steel
Structure finish: White

Diffuser material: Fabric shade
Diffuser finish: Brown

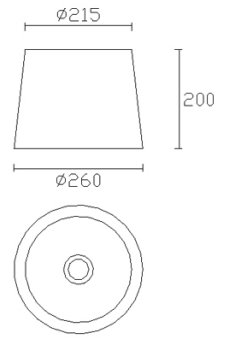

IP20

PAN-178-14



Structure material: Steel
Structure finish: White

Diffuser material: Fabric shade
Diffuser finish: White

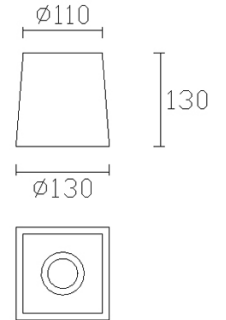

IP20

PAN-178-BY



Structure material: Steel
Structure finish: White

Diffuser material: Fabric shade
Diffuser finish: Sandblasted

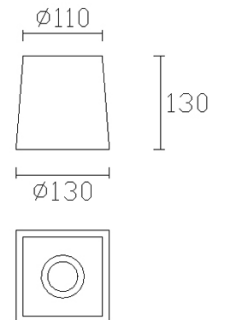

IP20

PAN-186-20



Structure material: Steel
Structure finish: White

Diffuser material: Fabric shade
Diffuser finish: Beige

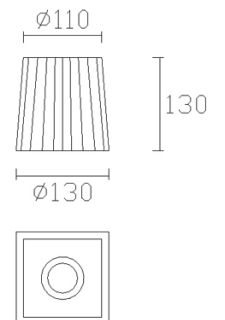

IP20

PAN-179-14



Structure material: Steel
Structure finish: White

Diffuser material: Fabric shade
Diffuser finish: White

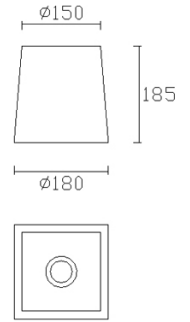

IP20

PAN-179-BY



Structure material: Steel
Structure finish: White

Diffuser material: Fabric shade
Diffuser finish: Sandblasted

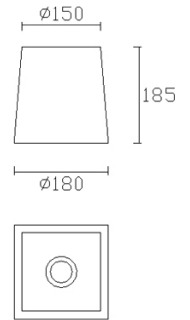

IP20

PAN-187-20



Structure material: Steel
Structure finish: White

Diffuser material: Fabric shade
Diffuser finish: Beige

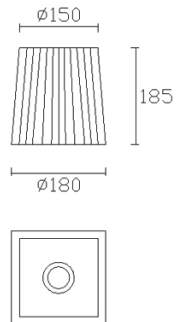

IP20

PAN-176-14

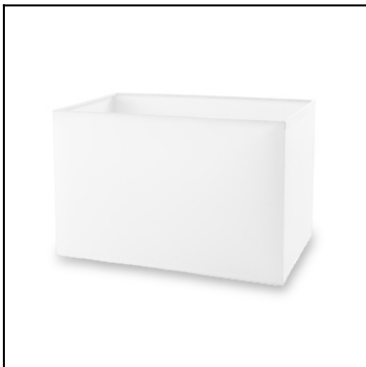

Structure material: Steel

Diffuser material: Fabric shade
Diffuser finish: White

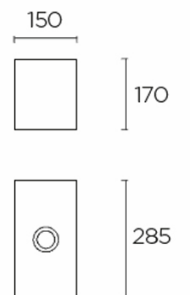

PAN-176-BY



Structure material: Steel
Diffuser material: Fabric shade
Diffuser finish: Sandblasted

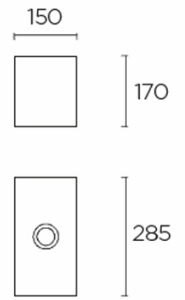

PAN-177-14



Structure material: Steel
Diffuser material: Fabric shade
Diffuser finish: White

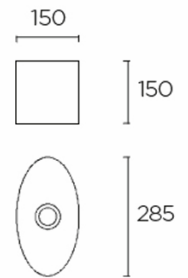

PAN-177-BY



Structure material: Steel
Diffuser material: Fabric shade
Diffuser finish: Sandblasted

