

OUT 

SHARPE

05-9602-34-M1

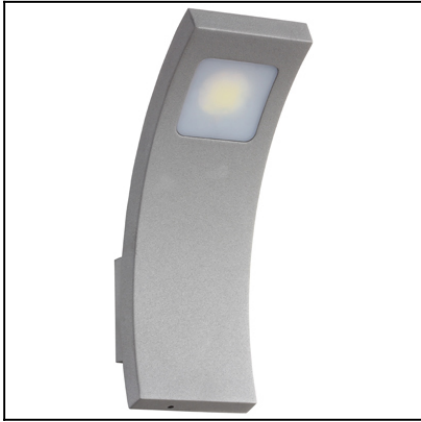

The photograph may not match the reference exactly. Please read the product description to identify the finish.

TECHNICAL CHARACTERISTICS

Type:	Wall fixture
IP Protection degrees:	IP44
Bulb:	3 x LED Cree. Neutral white (5000 - 3700 K)
Power (W):	1
Voltage / Frequency:	100-240V/50-60Hz
Warranty (Years):	2
Option to extend the guarantee:	Yes, 5 years
Units per box:	4
Net Weight (Kg):	0.355
EAN:	8435111089675,00

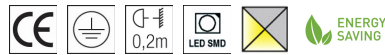
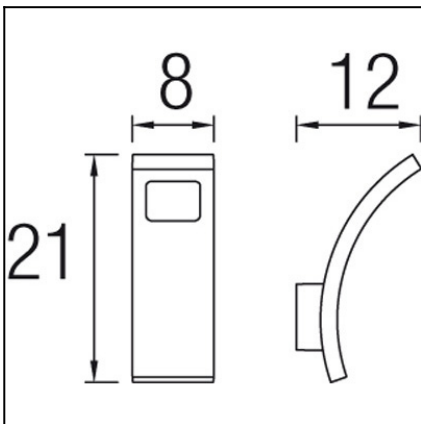

MATERIALS / FINISHES

Structure material: Injected aluminium
Structure finish: Grey

Diffuser material: Polycarbonate
Diffuser finish: Opal

GEAR

Multi-voltage electronic gear included (110-240 V / 50-60 Hz)

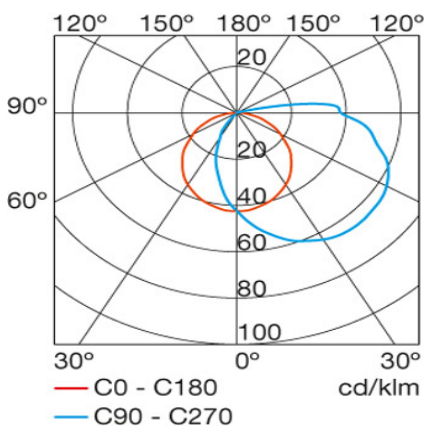

Download photometric file .ldt / .ies

Luminaria		Ensayo		Lámpara		
Código	05-9602	Código	05-9602	Código	05-9602	
Nombre	Aplique leds difusor opal	Nombre	Aplique leds difusor opal	Número	1	
Familia	- LEDS C4 LEDS	Fecha	18-11-2011	Posición	Universal	
Rendimiento	100.00%	Sist. de Coorden.	C-G	Flujo Total	170.50 lm	
Valor Máximo	65.43 cd	Posición	C=90.00 G=45.00	Sim. en los planos 270-90		
Luminaria Rectangular	Longit.	220 mm	Anchura	75 mm	Altura	100 mm
Área Luminosa Rectangular	Longit.	50 mm	Anchura	50 mm	Altura	0 mm
Área Luminosa Horizontal	0.002500 m2		Área Emisión sobre Pl. 180°		0.000000 m2	
Área Emisión sobre Pl. 0°	0.000000 m2		Área Emisión sobre Pl. 270°		0.000000 m2	
Área Emisión sobre Pl. 90°	0.000000 m2		Área de deslumbramiento a 76°		0.000605 m2	
Tipo de Simetría	Sim. en los planos 270-90		Máximo Ángulo Gamma		180	
Distancia de Ensayo	6.44		Flujo de Ensayo		170.50 lm	
Operador	Asselum T2		Tensión de alimentación		230.00 V	
Temperatura	22.00 °C		Corr. aliment.		PRC	
Humedad	50.00 %		Fotocélula			
Notas						

Lámparas de la Luminaria					
Familia	Código	Nombre	Flujo/lm	Pot.W	Cant.
- LEDS C4 LEDS	05-9602	Lámpara led blanco	170.50	5.00	1
C.I.E.	37 65 86 91 100	D DIN 5040		A21	
F UTE	0.91 H + 0.09 T	B NBN		BZ 6	

220mm x 75mm

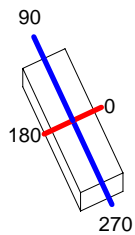

Semiplanos C
 270.0 ——— 0.0
 180.0 ——— 90.0

ULOR 9.41 %
 DLOR 90.59 %
 RN 9.41 %

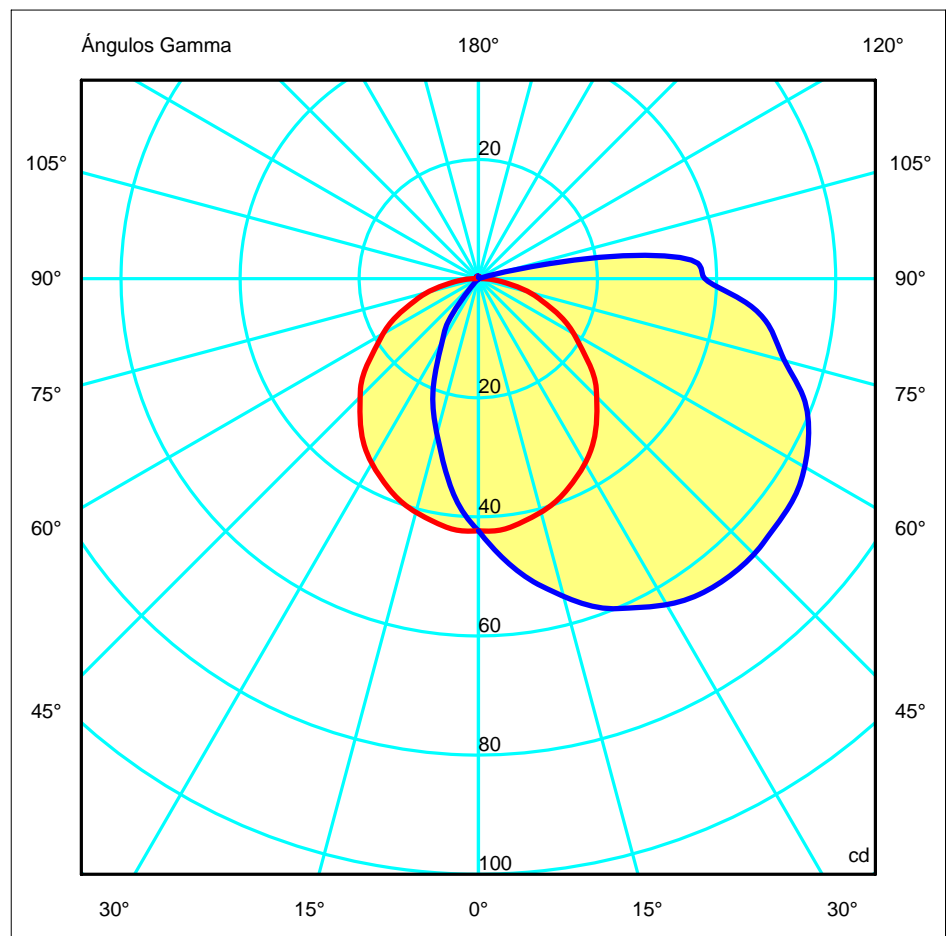

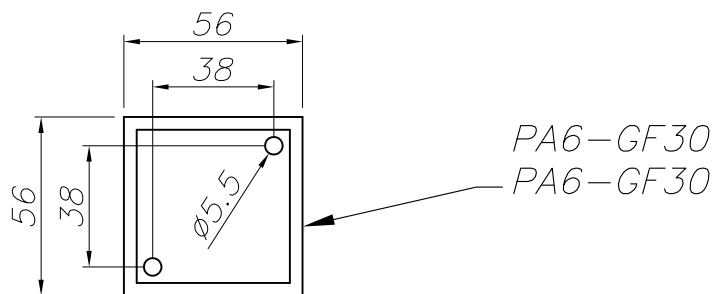
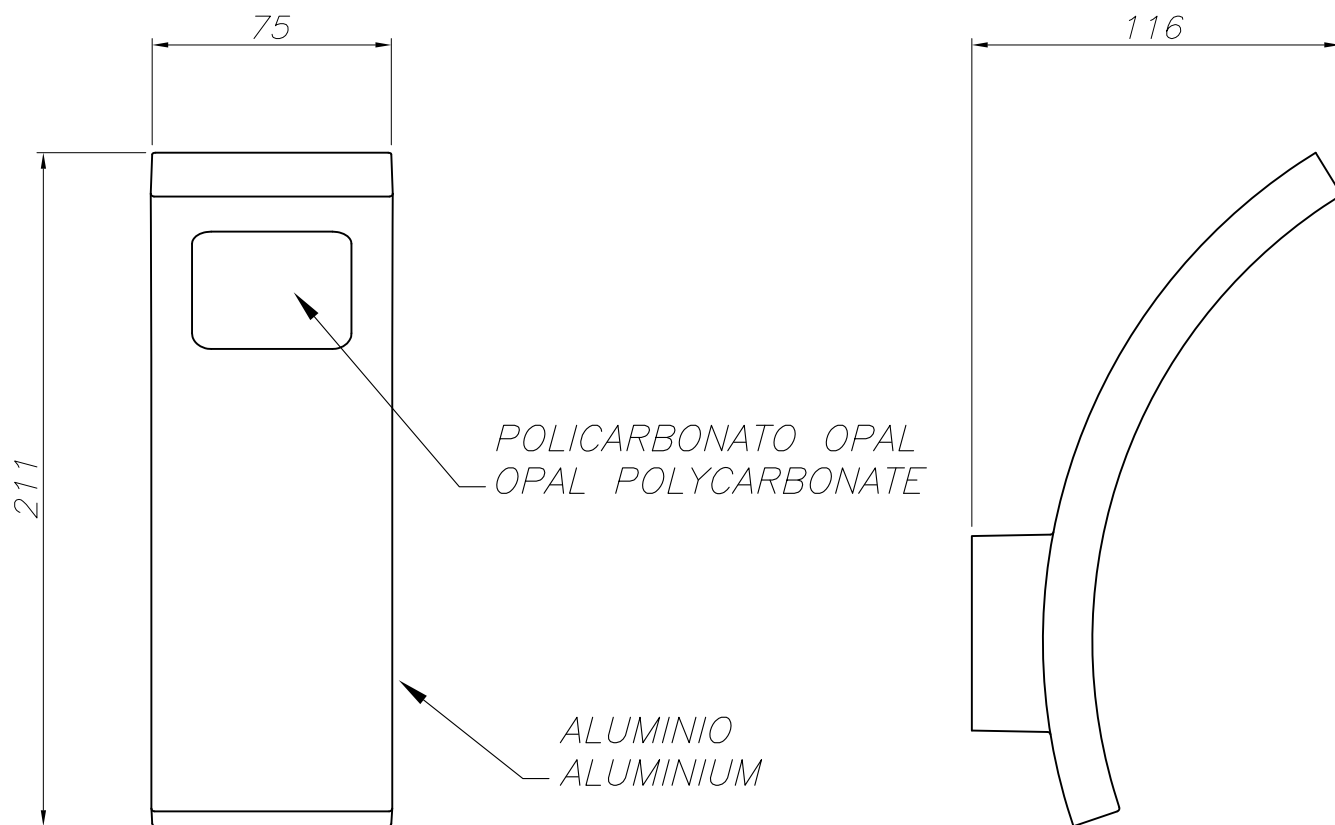

PLANTILLA DE INSTALACIÓN
INSTALLATION TEMPLATE

