

Design by Josep Patsí



The photograph may not match the reference exactly. Please read the product description to identify the finish.

TECHNICAL CHARACTERISTICS

Type:	Table lamp
Adjustable $\pm 180^\circ$ on the vertical axis	
IP Protection degrees:	IP20
Bulb:	1 x LED Cree. Warm White - 3000K
Power (W):	4.5W
Luminous efficacy (Lm/W):	70
Voltage / Frequency:	100-240V/50-60Hz
Possibilitat extensió garantia:	Sí, 5 anys
Units per box:	1
Net Weight (Kg):	2.78
EAN:	8435111059074

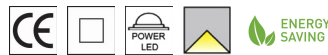
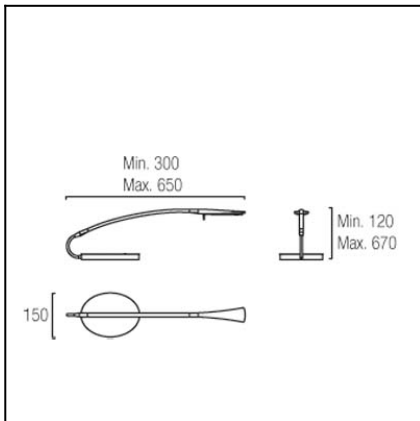

MATERIALS / FINISHES

Structure material: Aluminium Steel	Diffuser material: Polycarbonate
Structure finish: Chrome	Diffuser finish: Transparent

GEAR

Multi-voltage electronic gear included (110-240 V / 50-60 Hz)

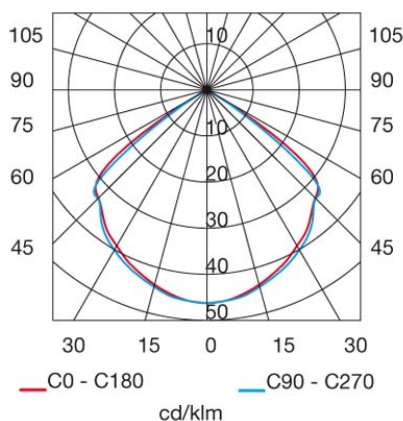

Download photometric file .ldt / .ies

Luminaria		Ensayo		Lámpara	
Código	10-2709-21-21	Código	05-2708-21-21	Código	LAMP 05-2708-21-21
Nombre	Sobremesa OPEN 4.5W led	NombreAplicación	OPEN 4.5W led	Número	1
Familia	- LEDS C4 LEDS	Fecha	08-04-2010	Posición	Universal
Eficiencia	100.00%	Sist. de Coorden.	C-G	Flujo Total	101.19 lm
Valor Máximo	46.26 cd	Posición	C=0.00 G=0.00	Bisimétrico	

175mm x 50mm

Semiplanos C

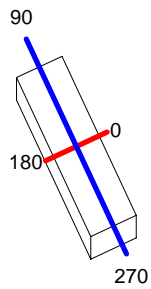

180.0 ——— 0.0
270.0 ——— 90.0

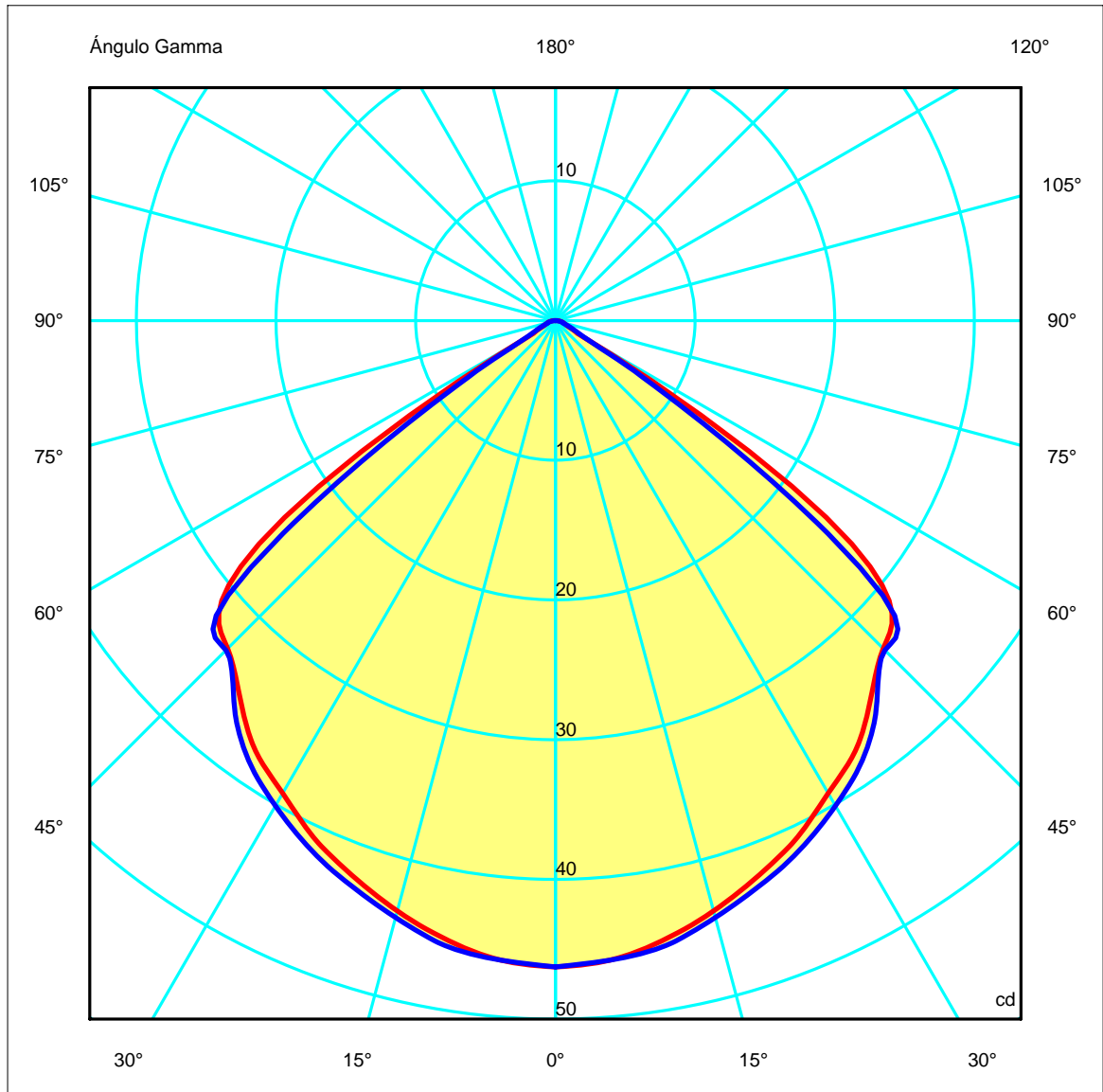

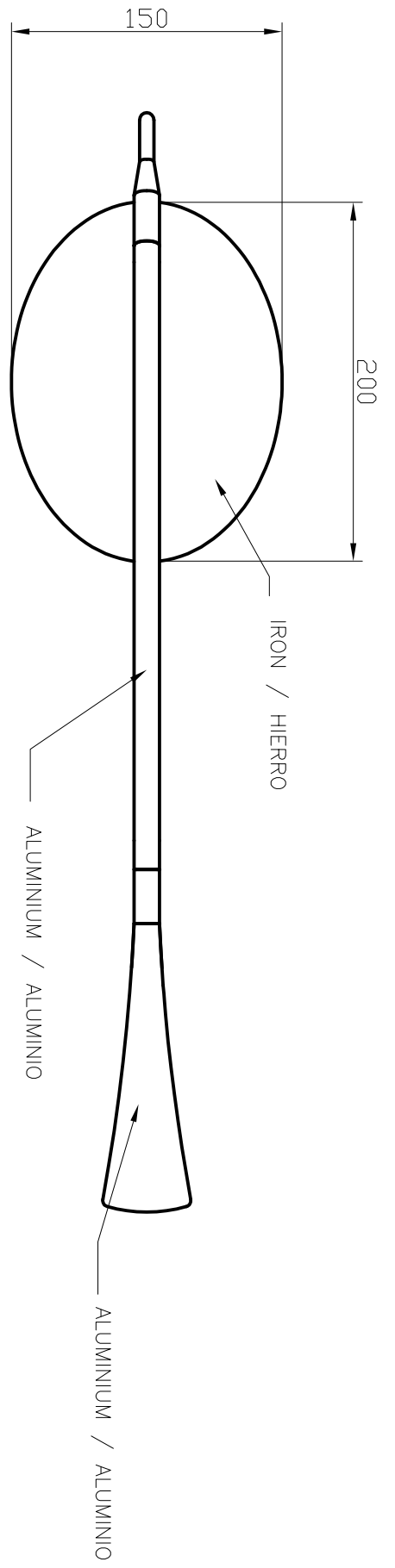
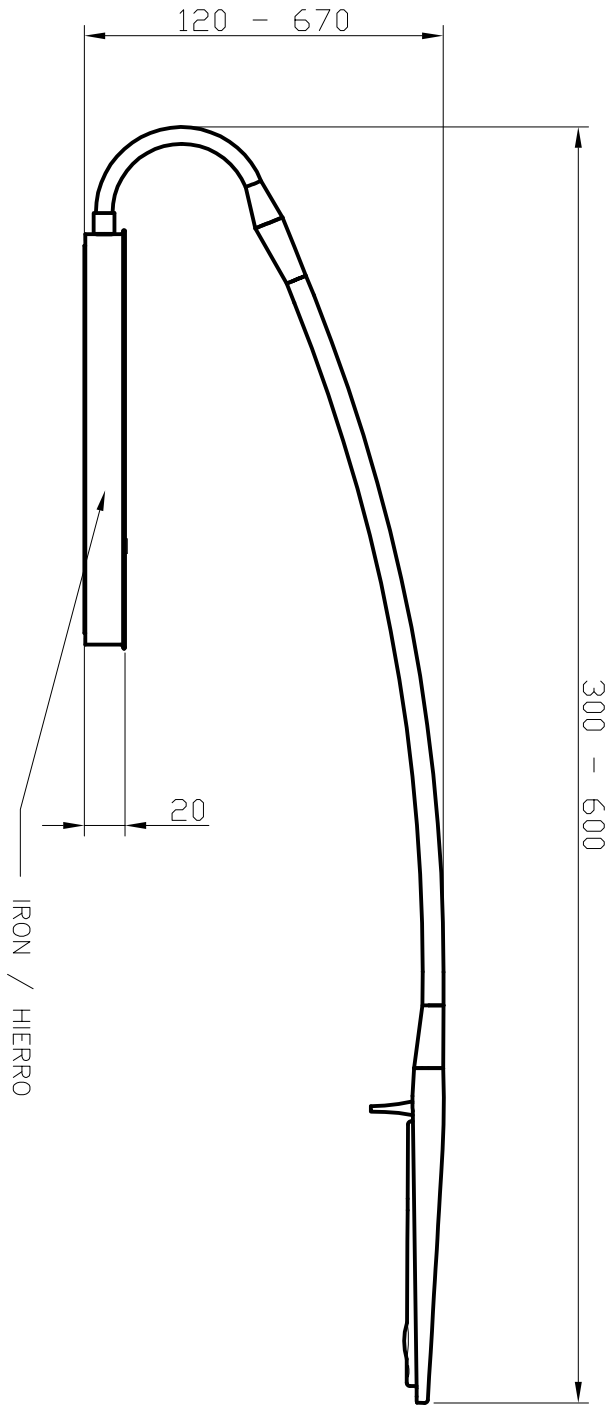

1

