

Design by Nahtrang Design

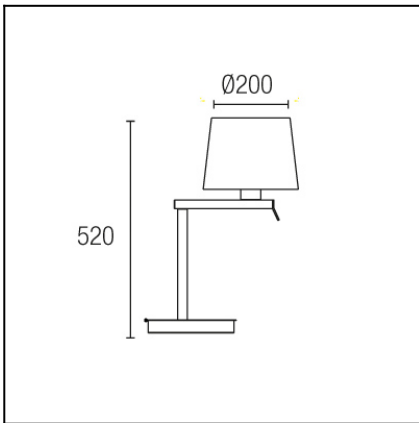

The photograph may not match the reference exactly. Please read the product description to identify the finish.



Download photometric file .ldt / .ies

TECHNICAL CHARACTERISTICS

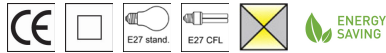
Type:	Table lamp
Adjustable 350° on the vertical axis.	
IP Protection degrees:	IP20
Lampholder:	1 x E27 1 x E27
Power (W):	E27 60w E27 18w
Total power consumption (W):	60
Voltage / Frequency:	220-240V/50-60Hz
Warranty (Years):	2
Units per box:	4
Net Weight (Kg):	2.49
EAN:	8435111086711,00



MATERIALS / FINISHES

Structure material: Steel
Structure finish: Old brown

PAN-157-14

Structure material: Steel
Structure finish: White

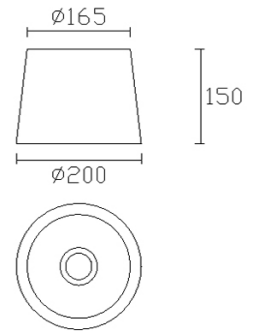
Diffuser material: Fabric shade
Diffuser finish: White



IP20

PAN-157-BY

Structure material: Steel
Structure finish: White

Diffuser material: Fabric shade
Diffuser finish: Sandblasted

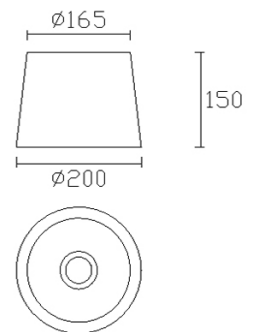

IP20

PAN-158-J6

Structure material: Steel
Structure finish: White

Diffuser material: Fabric shade
Diffuser finish: Brown

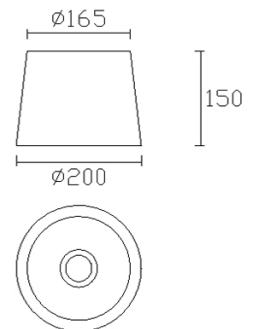

IP20

PAN-169-14

Structure material: Steel
Structure finish: White

Diffuser material: Fabric shade
Diffuser finish: White

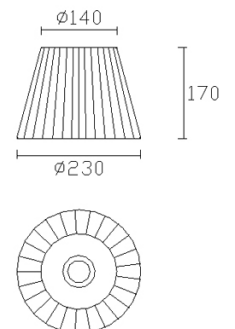

IP20

PAN-161-14



Structure material: Steel
Structure finish: White

Diffuser material: Fabric shade
Diffuser finish: White

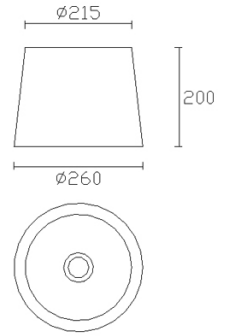

IP20

PAN-161-BY



Structure material: Steel
Structure finish: White

Diffuser material: Fabric shade
Diffuser finish: Sandblasted

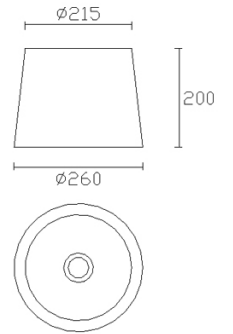

IP20

PAN-162-J6



Structure material: Steel
Structure finish: White

Diffuser material: Fabric shade
Diffuser finish: Brown

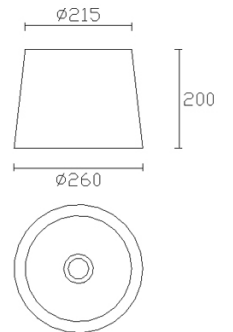

IP20

PAN-179-14



Structure material: Steel
Structure finish: White

Diffuser material: Fabric shade
Diffuser finish: White

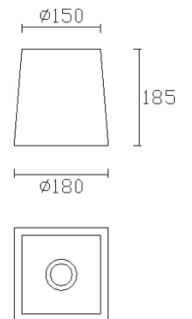

IP20

PAN-179-BY



Structure material: Steel
Structure finish: White
Diffuser material: Fabric shade
Diffuser finish: Sandblasted

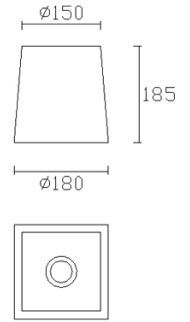

IP20

PAN-187-20



Structure material: Steel
Structure finish: White
Diffuser material: Fabric shade
Diffuser finish: Beige

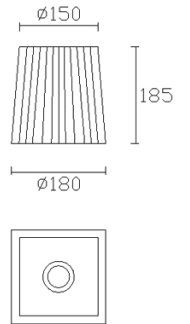

IP20

PAN-180-14



Structure material: Steel
Structure finish: White
Diffuser material: Fabric shade
Diffuser finish: White

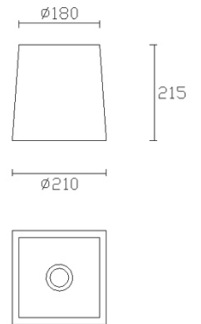

IP20

PAN-180-BY



Structure material: Steel
Structure finish: White
Diffuser material: Fabric shade
Diffuser finish: Sandblasted

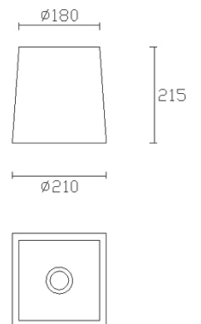

IP20

PAN-188-20

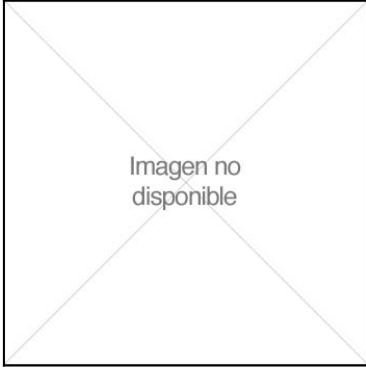

Structure material: Steel
Structure finish: White
Diffuser material: Fabric shade
Diffuser finish: Beige

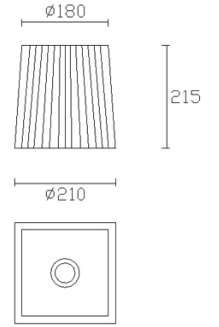

IP20

PAN-176-14



Structure material: Steel
Diffuser material: Fabric shade
Diffuser finish: White

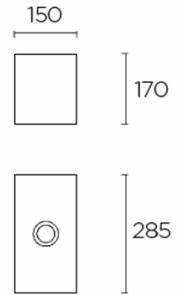

PAN-176-BY



Structure material: Steel
Diffuser material: Fabric shade
Diffuser finish: Sandblasted

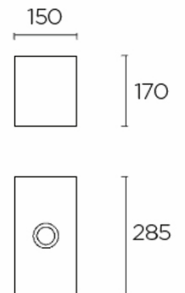

PAN-177-14



Structure material: Steel
Diffuser material: Fabric shade
Diffuser finish: White

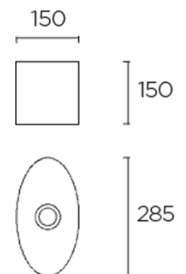

PAN-177-BY



Structure material: Steel

Diffuser material: Fabric shade

Diffuser finish: Sandblasted

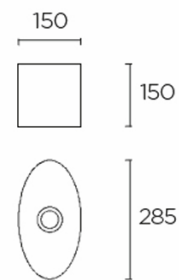

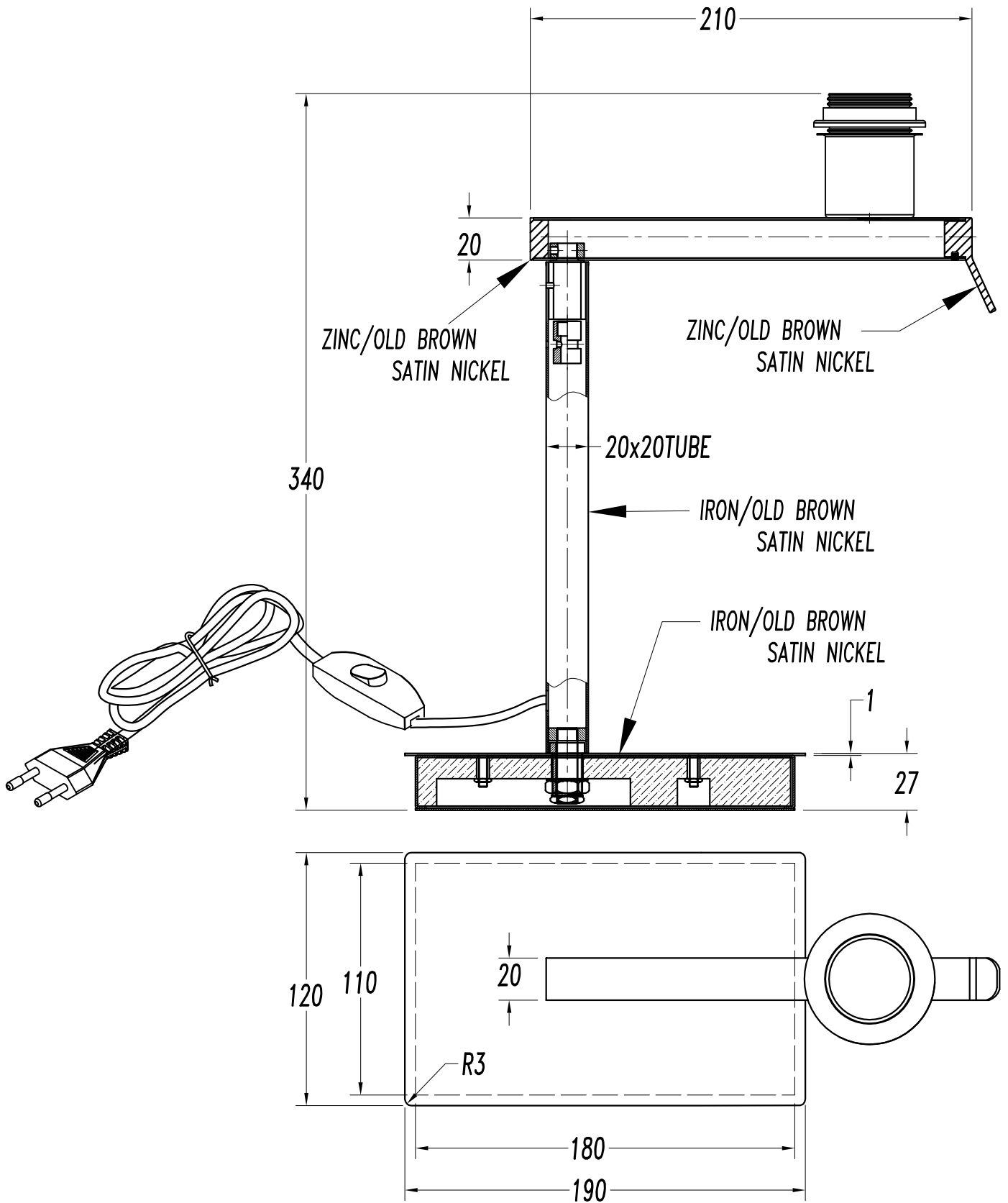

1

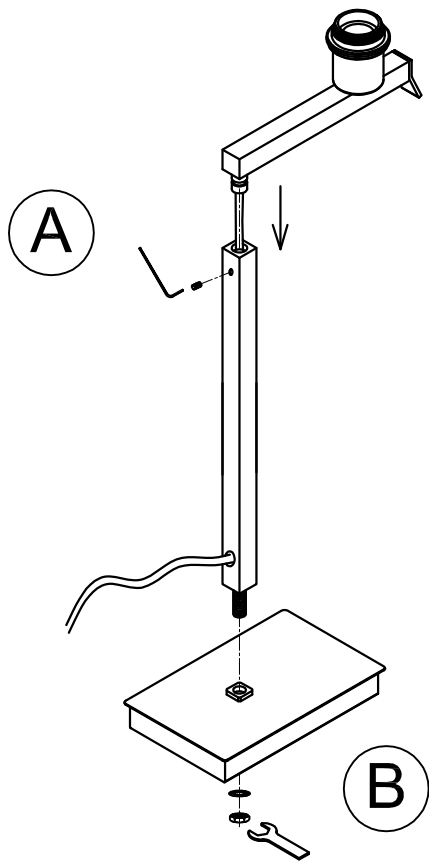

2

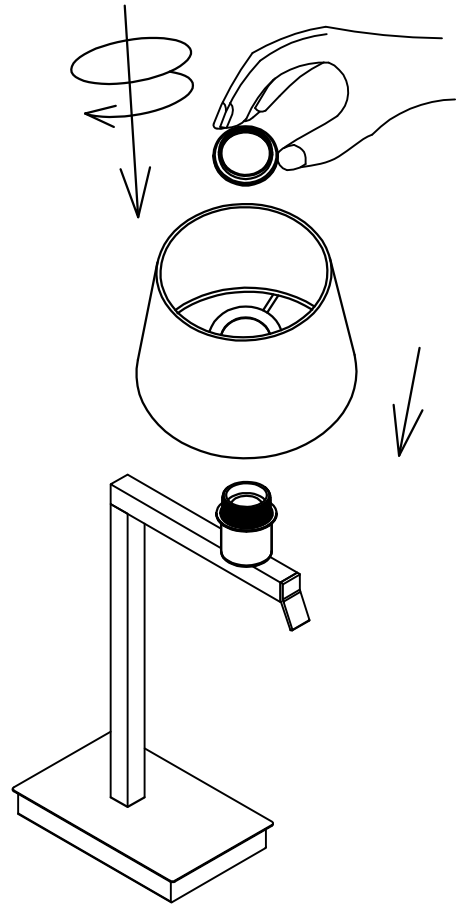

3

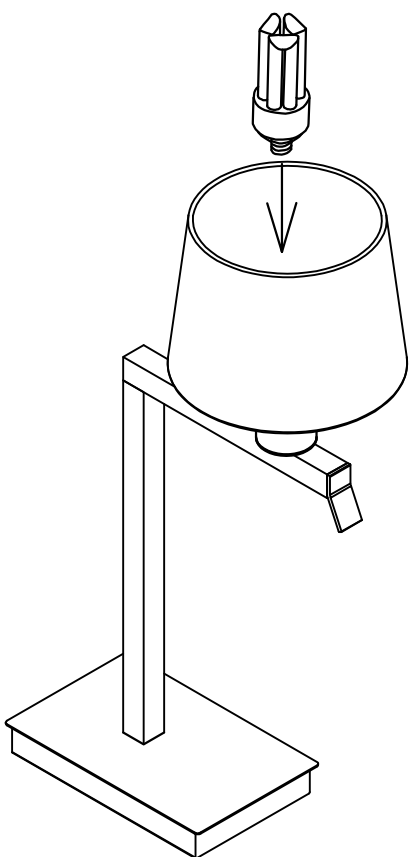

4

