

OUT 

MÜLLER 10-9557-Z5-M3

Design by Francesc Vilaró



The photograph may not match the reference exactly. Please read the product description to identify the finish.

TECHNICAL CHARACTERISTICS

Type:	Beacon
IP Protection degrees:	IP54
IK Protection degrees:	IK08
Bulb:	1 x LED Edison. Neutral white (5000 - 3700 K)
Power (W):	8W
Total power consumption (W):	12.4
Voltage / Frequency:	100-240V/50-60Hz
Possibilitat extensió garantia:	Sí, 5 anys
Units per box:	4
Net Weight (Kg):	2.8
EAN:	8435111089064

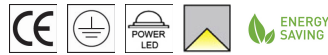
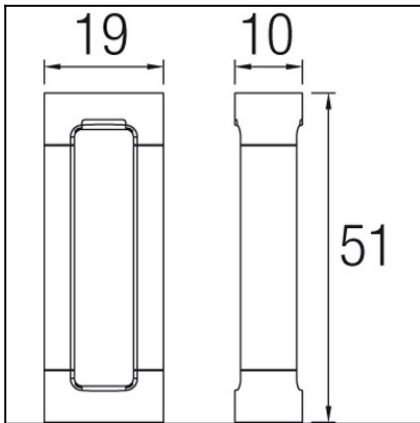

MATERIALS / FINISHES

Structure material:	High purity aluminium	Diffuser material:	Polycarbonate
Structure finish:	Urban grey	Diffuser finish:	Matt

GEAR

Multi-voltage electronic gear included (110-240 V / 50-60 Hz)

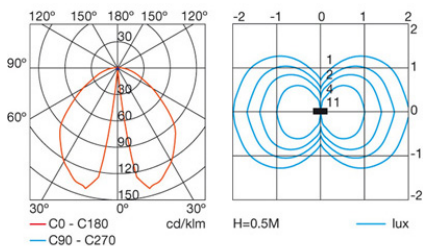

Download photometric file .ldt /.ies

Luminaria		Ensayo		Lámpara		
Código	10-9557	Código	10-9557	Código	10-9557	
Nombre	Baliza leds difusor opal	Nombre	Baliza leds difusor opal	Número	1	
Familia	- LEDS C4 LEDS	Fecha	14-11-2011	Posición	Universal	
Rendimiento	100.00%	Sist. de Coord.	C-G	Flujo Total	203.46 lm	
Valor Máximo	141.64 cd	Posición	C=0.00 G=15.00	Bisimétrico		
Luminaria Rectangular	Longit.	185 mm	Anchura	105 mm	Altura	505 mm
Área Luminosa Rectangular	Longit.	65 mm	Anchura	105 mm	Altura	5 mm
Área Luminosa Horizontal	0.006825 m2	Área Emisión sobre Pl. 180°		0.000325 m2		
Área Emisión sobre Pl. 0°	0.000325 m2	Área Emisión sobre Pl. 270°		0.000525 m2		
Área Emisión sobre Pl. 90°	0.000525 m2	Área de deslumbramiento a 76°		0.001966 m2		
Tipo de Simetría	Bisimétrico	Máximo Ángulo Gamma		180		
Distancia de Ensayo	6.44	Flujo de Ensayo		203.46 lm		
Operador	Asselum T2	Tensión de alimentación		230.00 V		
Temperatura	22.00 °C	Corr. aliment.		PRC		
Humedad	50.00 %	Fotocélula				
Notas						

Familia		Código		Lámparas de la Luminaria		
- LEDS C4 LEDS		10-9557		Nombre	Flujo/lm	Pot.W
				Lámpara led blanco	203.46	12.00
C.I.E.	53 82 95 96 100			D DIN 5040		
F UTE	0.96 D + 0.04 T			B NBN	A41	
					BZ 4	

185mm x 105mm

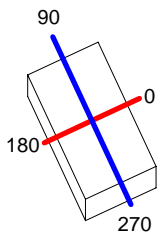

Semiplanos C

180.0 — 0.0

270.0 — 90.0

ULOR 4.09 %

DLOR 95.91 %

RN 4.09 %

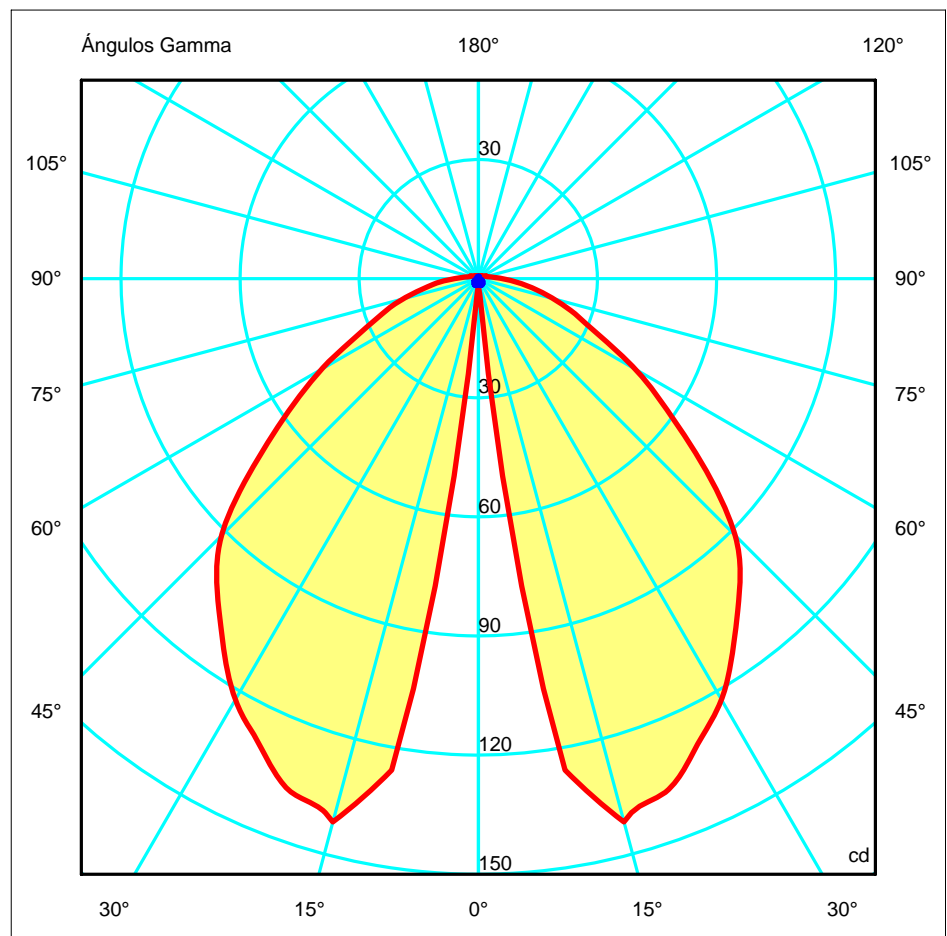

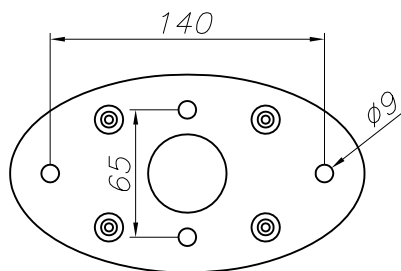
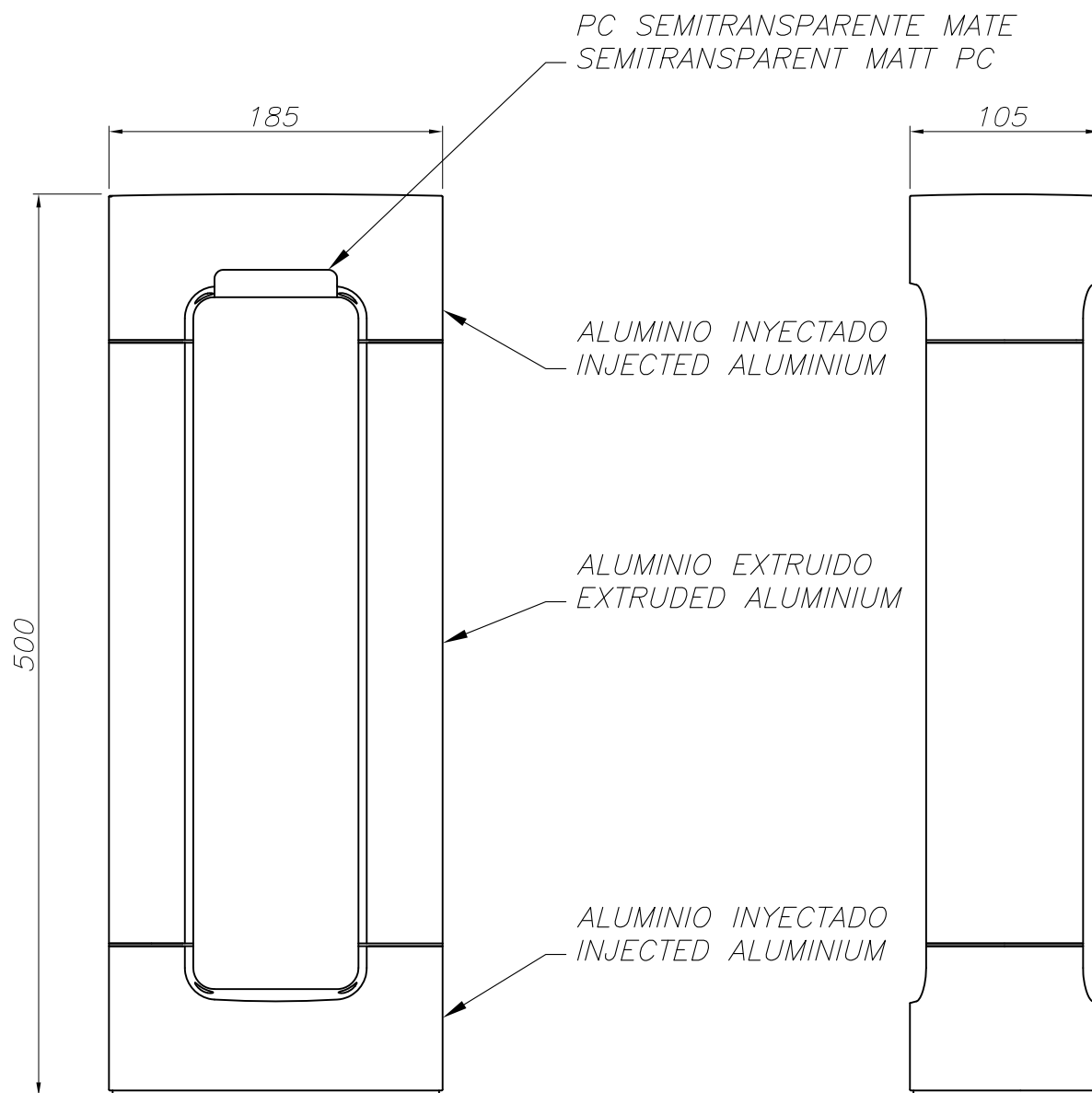

PLANTILLA DE INSTALACIÓN
INSTALLATION TEMPLATE

