

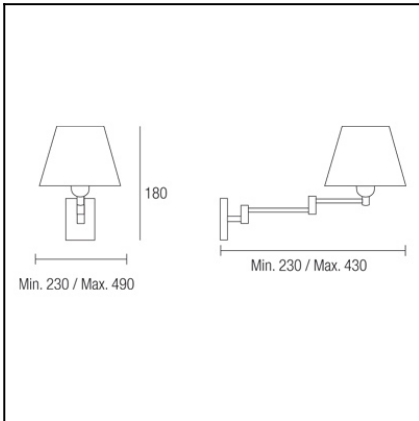

The photograph may not match the reference exactly. Please read the product description to identify the finish.



Download photometric file .ldt /.ies

TECHNICAL CHARACTERISTICS

Type:	Wall fixture
IP Protection degrees:	IP20
Lampholder:	1 x E27
Power (W):	E27 MAX 60W
Total power consumption (W):	60
Voltage / Frequency:	220-240V/50-60Hz
Units per box:	5
Net Weight (Kg):	0.53
EAN:	8435071499958



MATERIALS / FINISHES

Structure material: Steel

Structure finish: Satin nickel

PAN-175-14

Structure material: Steel
Structure finish: White

Diffuser material: Fabric shade
Diffuser finish: White

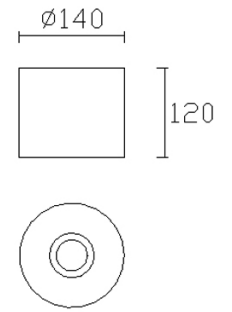

IP20

PAN-175-BY

Structure material: Steel
Structure finish: White

Diffuser material: Fabric shade
Diffuser finish: Sandblasted

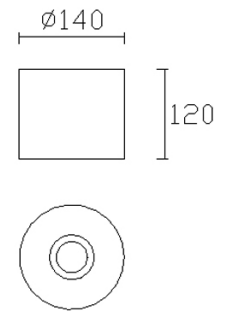

IP20

PAN-157-14

Structure material: Steel
Structure finish: White

Diffuser material: Fabric shade
Diffuser finish: White

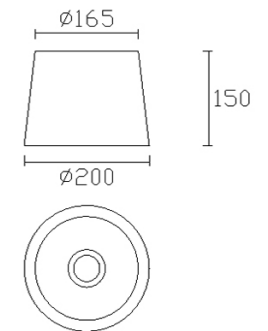

IP20

PAN-157-BY

Structure material: Steel
Structure finish: White

Diffuser material: Fabric shade
Diffuser finish: Sandblasted

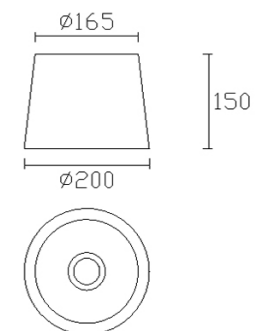

IP20

PAN-158-J6



Structure material: Steel
Structure finish: White
Diffuser material: Fabric shade
Diffuser finish: Brown

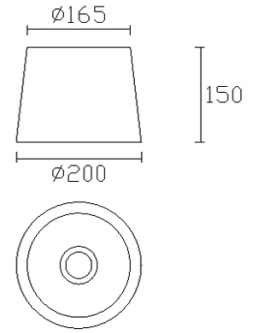

IP20

PAN-169-14



Structure material: Steel
Structure finish: White
Diffuser material: Fabric shade
Diffuser finish: White

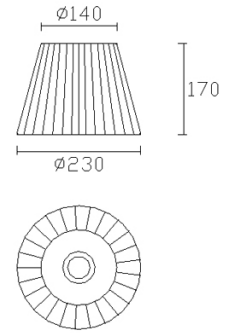

IP20

PAN-178-14



Structure material: Steel
Structure finish: White
Diffuser material: Fabric shade
Diffuser finish: White

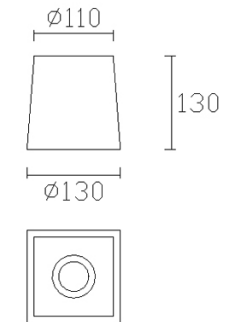

IP20

PAN-178-BY



Structure material: Steel
Structure finish: White
Diffuser material: Fabric shade
Diffuser finish: Sandblasted

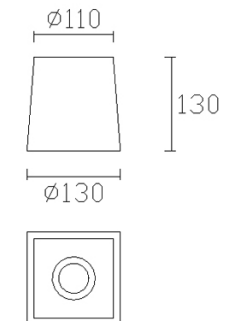

IP20

PAN-186-20

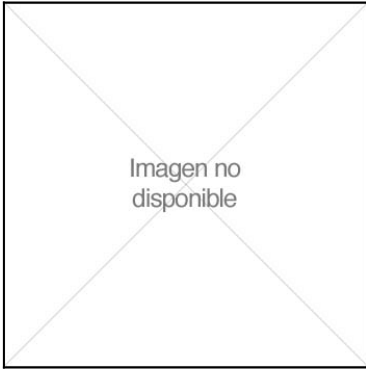

Structure material: Steel
Structure finish: White
Diffuser material: Fabric shade
Diffuser finish: Beige

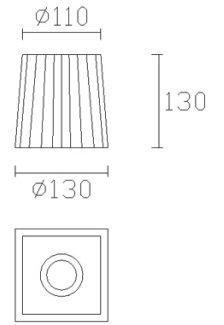

IP20

PAN-179-14



Structure material: Steel
Structure finish: White
Diffuser material: Fabric shade
Diffuser finish: White

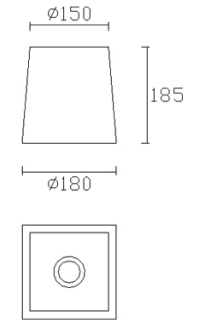

IP20

PAN-179-BY



Structure material: Steel
Structure finish: White
Diffuser material: Fabric shade
Diffuser finish: Sandblasted

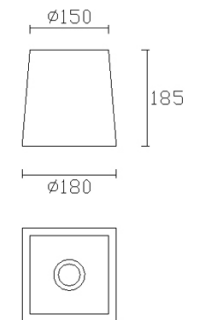

IP20

PAN-187-20



Structure material: Steel
Structure finish: White
Diffuser material: Fabric shade
Diffuser finish: Beige

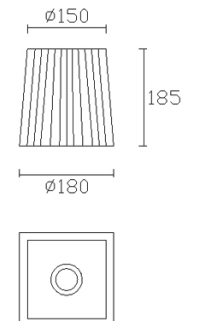

IP20

PAN-176-14



Structure material: Steel
Diffuser material: Fabric shade
Diffuser finish: White

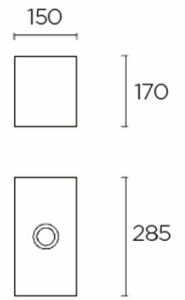

PAN-176-BY



Structure material: Steel
Diffuser material: Fabric shade
Diffuser finish: Sandblasted

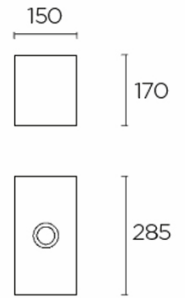

PAN-177-14



Structure material: Steel
Diffuser material: Fabric shade
Diffuser finish: White

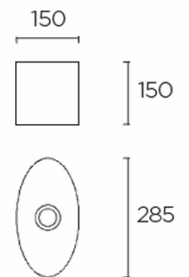

PAN-177-BY



Structure material: Steel
Diffuser material: Fabric shade
Diffuser finish: Sandblasted

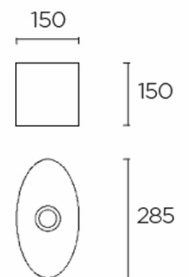

Luminaria		Ensayo		Lámpara	
Código	170-NS	Código	172-NS	Código	CLAS A CL 60
Nombre	Apliche DOVER 1x60W E27 incand	NombreApliche	DOVER 60W E27 incan	Número	1
Familia	- LEDS-C4	Fecha	22-04-2010	Posición	Universal
Eficiencia	67.22%	Sist. de Coordin.	C-G	Flujo Total	710.00 lm
Valor Máximo	100.07 cd	Posición	C=90.00 G=40.00	Bisimétrico	

Diam=230mm

Semiplanos C

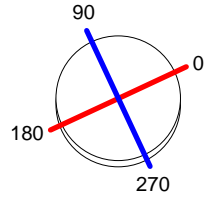

180.0 ——— 0.0
270.0 ——— 90.0

