

Design by Estudi Ribaudí

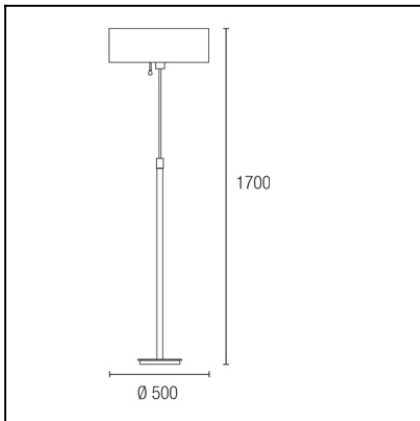

The photograph may not match the reference exactly. Please read the product description to identify the finish.



TECHNICAL CHARACTERISTICS

Type:	Floor lamp
IP Protection degrees:	IP20
Lampholder:	1 x E27
Power (W):	E27 MAX 150W
Bulb included:	1 x E27 MAX 150W
Total power consumption (W):	150
Voltage / Frequency:	220-240V/50-60Hz
Units per box:	1
Net Weight (Kg):	17
EAN:	8435111059715



MATERIALS / FINISHES

Structure material: Steel

Diffuser material: Fabric shade
Glass

Structure finish: Satin nickel

Diffuser finish: Opera grey
Satin

[Download photometric file .ldt / .ies](#)

Luminaria		Ensayo		Lámpara	
Código	25-2713-81-AJ	Código	25-2713-81-AJ	Código	64478
Nombre	Pie UP & DOWN 150W E27 opal	Nombre	Pie UP & DOWN 150W E27 opal	Número	1
Familia	- LEDS-C4	Fecha	14-09-2010	Posición	Universal
Eficiencia	28.64%	Sist. de Coorden.	C-G	Flujo Total	2500.00 lm
Valor Máximo	146.64 cd	Posición	C=0.00 G=30.00	Bisimétrico	

Diam=500mm

Semiplanos C

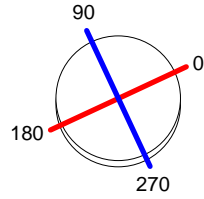

180.0 ——— 0.0
 270.0 ——— 90.0

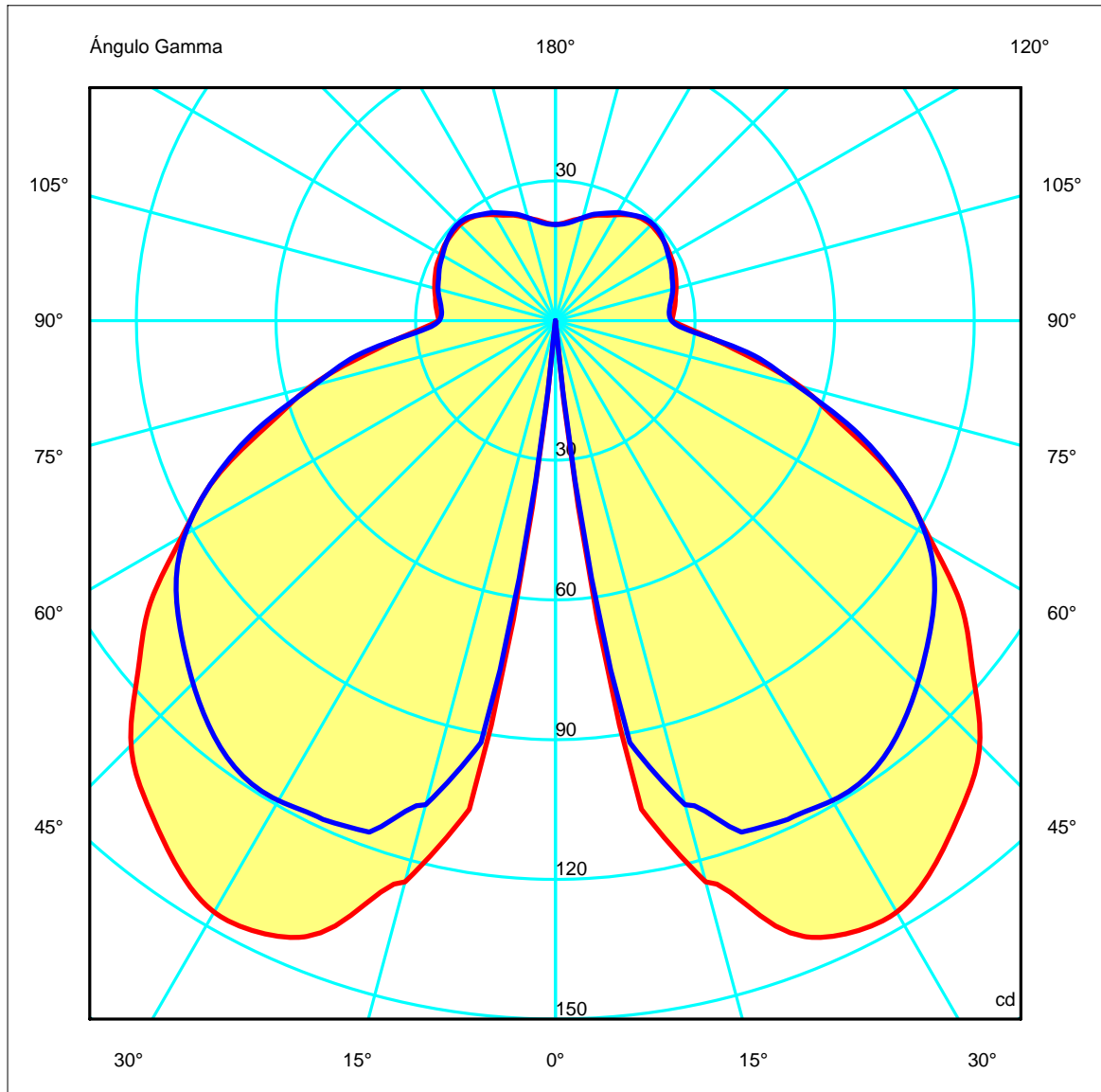

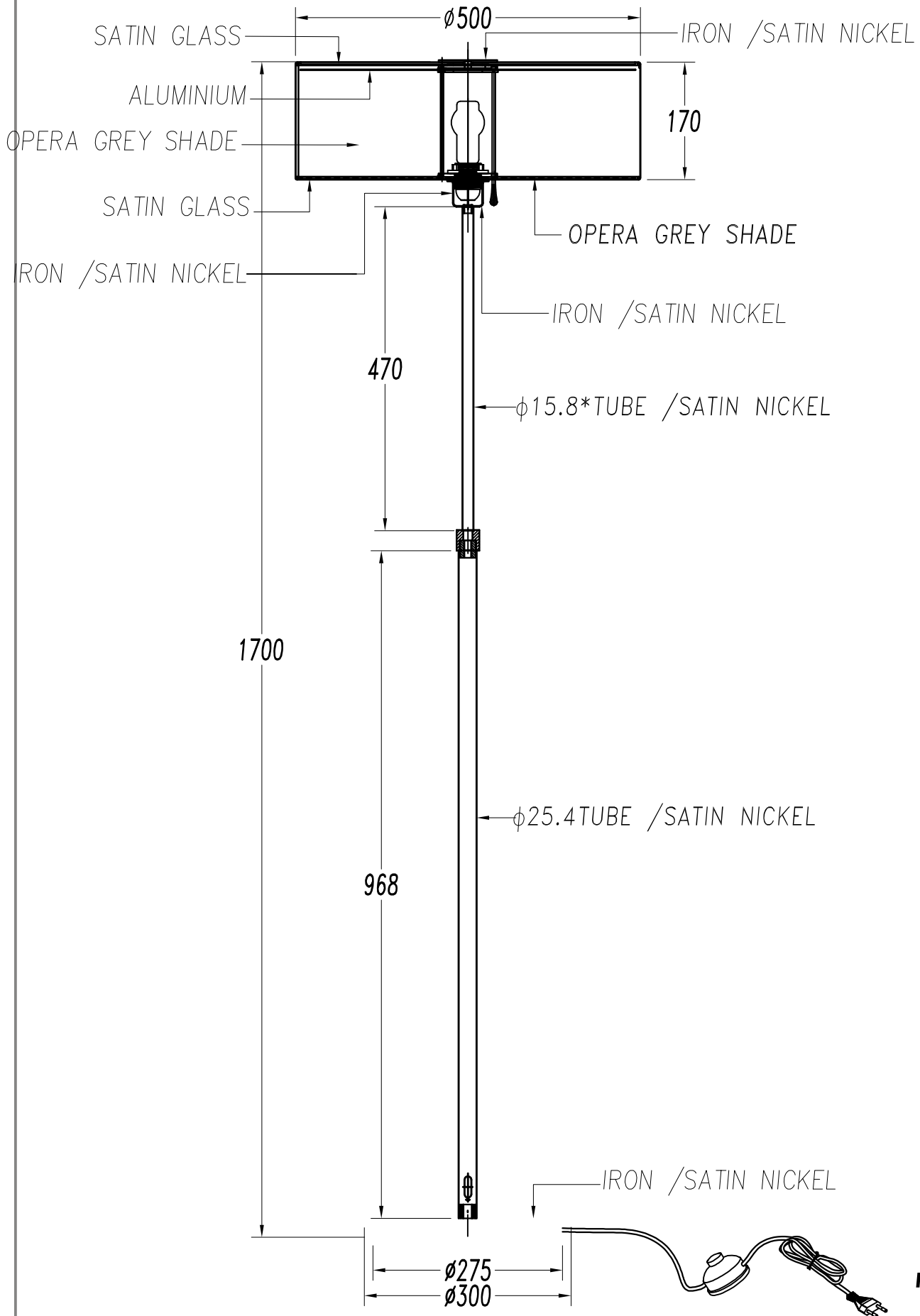

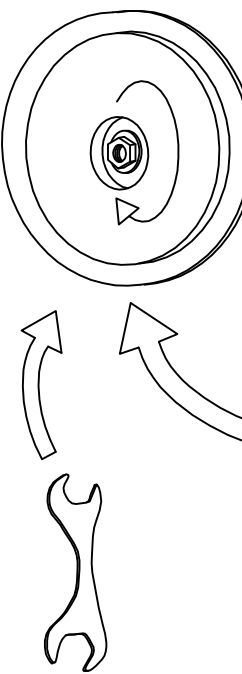

3

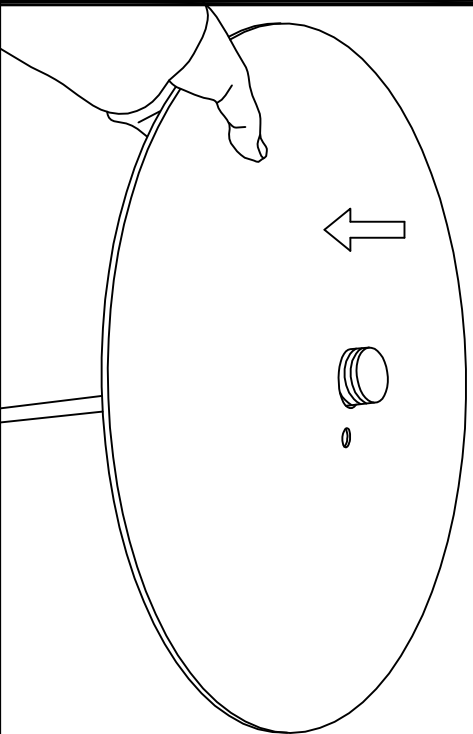

4

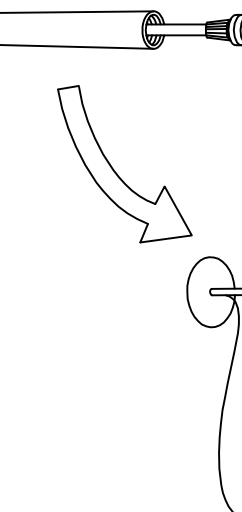

5

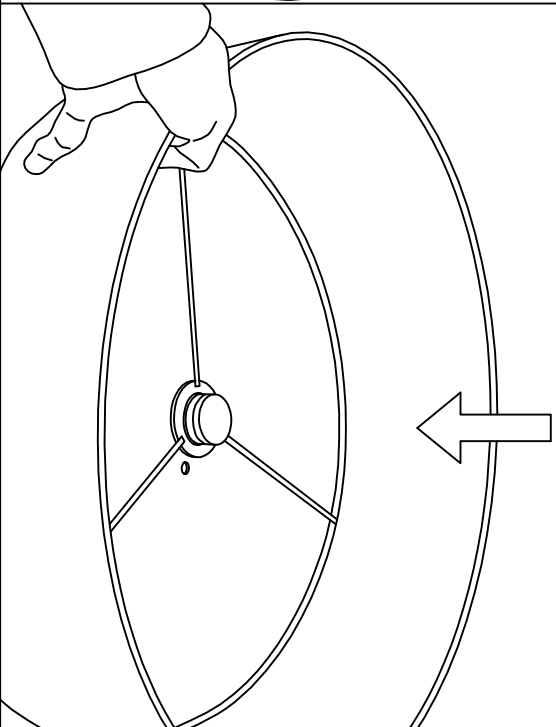

6

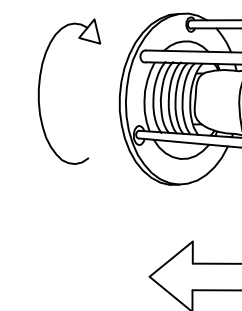

7

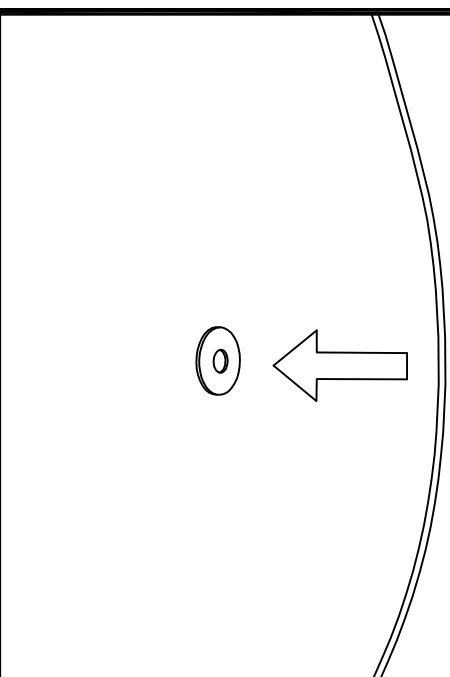

8

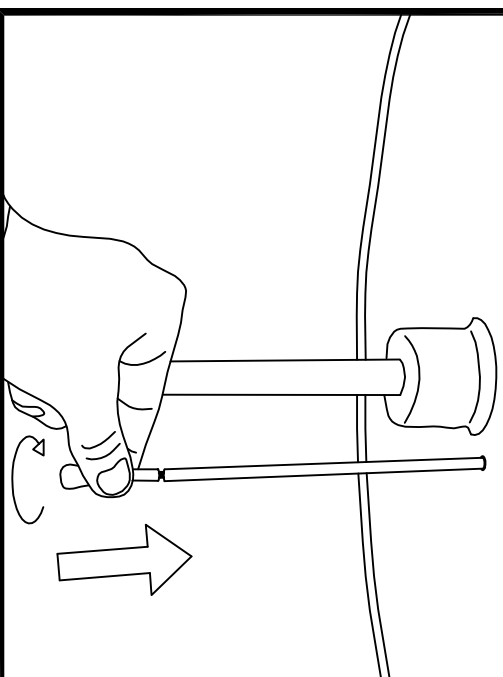
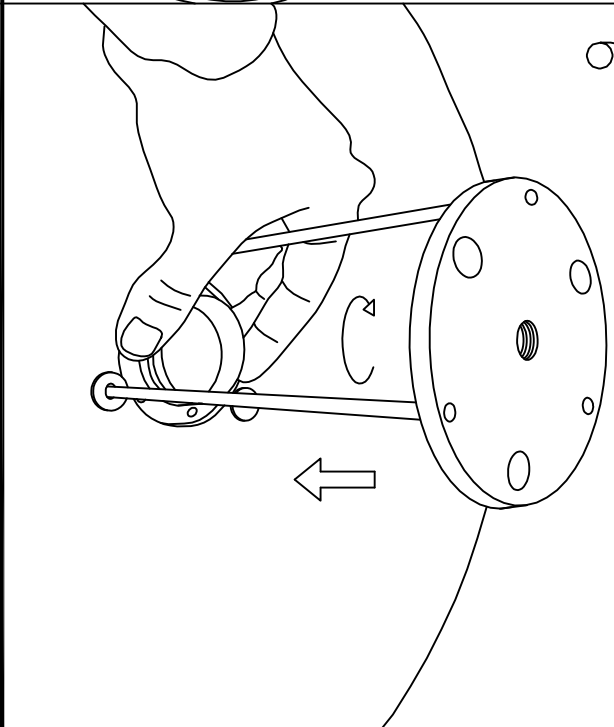
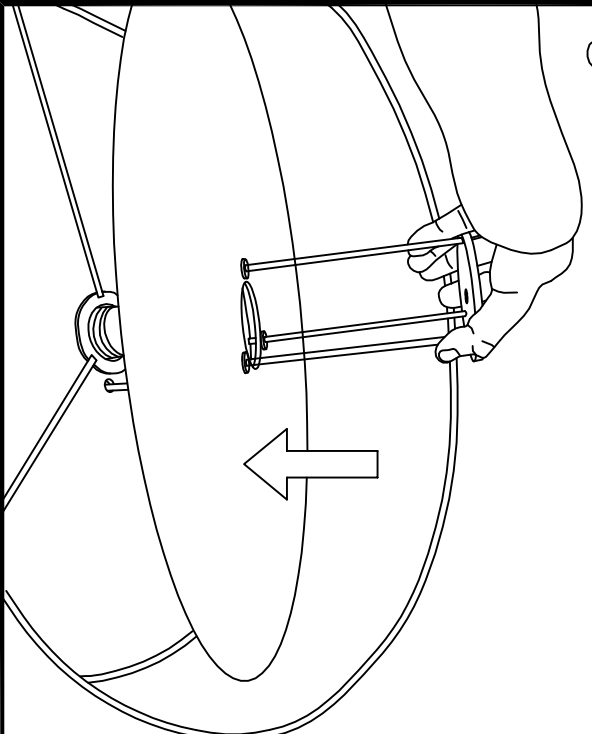

11