

Design by Nahtrang Design

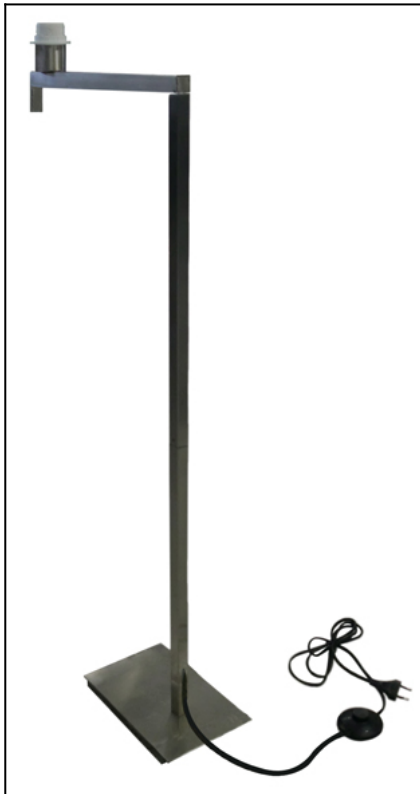

The photograph may not match the reference exactly. Please read the product description to identify the finish.

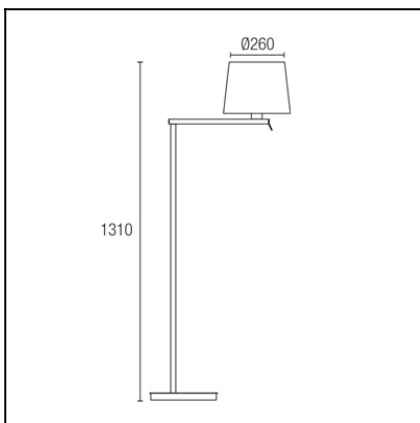

Download photometric file .ldt /.ies

TECHNICAL CHARACTERISTICS

Type:	Floor lamp
Adjustable 350° on the vertical axis.	
IP Protection degrees:	IP20
Lampholder:	1 x E27 1 x E27
Power (W):	E27 100w E27 23w
Total power consumption (W):	100
Voltage / Frequency:	220-240V/50-60Hz
Units per box:	4
Net Weight (Kg):	6.07
EAN:	8435111086575

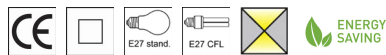

MATERIALS / FINISHES

Structure material: Steel

Structure finish: Satin nickel
Matt

PAN-161-14

Structure material: Steel
Structure finish: White

Diffuser material: Fabric shade
Diffuser finish: White

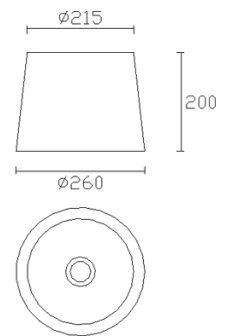

IP20

PAN-161-BY

Structure material: Steel
Structure finish: White

Diffuser material: Fabric shade
Diffuser finish: Sandblasted

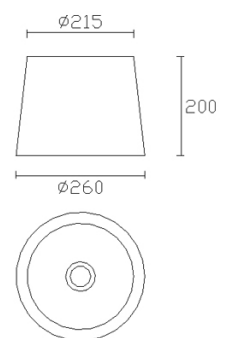

IP20

PAN-162-J6

Structure material: Steel
Structure finish: White

Diffuser material: Fabric shade
Diffuser finish: Brown

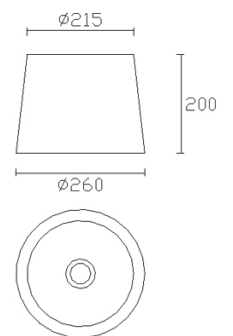

IP20

PAN-184-BY

Structure material: Steel
Structure finish: White

Diffuser material: Fabric shade
Diffuser finish: Sandblasted

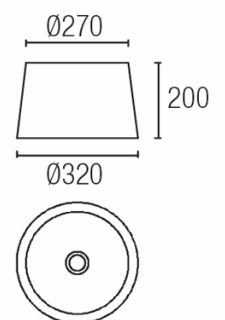

IP20

PAN-184-14



Structure material: Steel
Structure finish: White
Diffuser material: Fabric shade
Diffuser finish: White

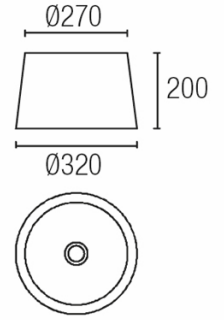

PAN-185-J6



Structure material: Steel
Diffuser material: Fabric shade
Diffuser finish: Brown

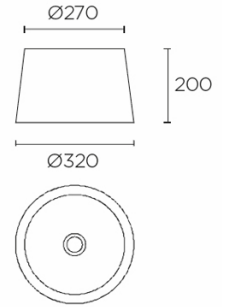

PAN-180-14



Structure material: Steel
Structure finish: White
Diffuser material: Fabric shade
Diffuser finish: White

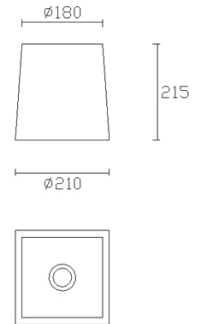

IP20

PAN-180-BY



Structure material: Steel
Structure finish: White
Diffuser material: Fabric shade
Diffuser finish: Sandblasted

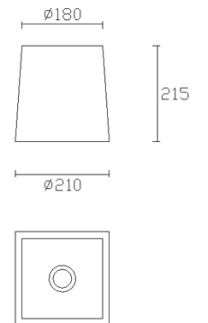

IP20

PAN-188-20



Structure material: Steel
Structure finish: White
Diffuser material: Fabric shade
Diffuser finish: Beige

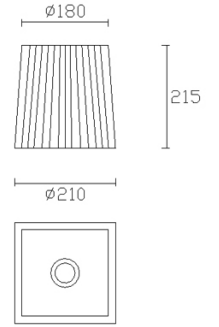

IP20

PAN-181-14



Structure material: Steel
Structure finish: White
Diffuser material: Fabric shade
Diffuser finish: White

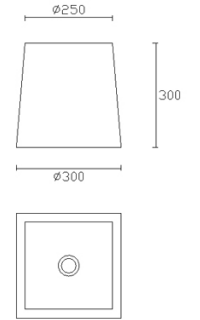

IP20

PAN-181-BY



Structure material: Steel
Structure finish: White
Diffuser material: Fabric shade
Diffuser finish: Sandblasted

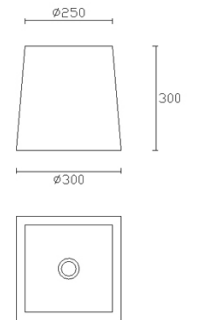

IP20

PAN-189-20



Structure material: Steel
Structure finish: White
Diffuser material: Fabric shade
Diffuser finish: Beige

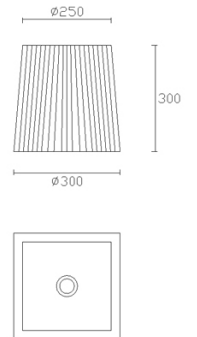

IP20

PAN-176-14



Structure material: Steel
Diffuser material: Fabric shade
Diffuser finish: White

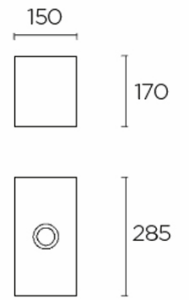

PAN-176-BY



Structure material: Steel
Diffuser material: Fabric shade
Diffuser finish: Sandblasted

