

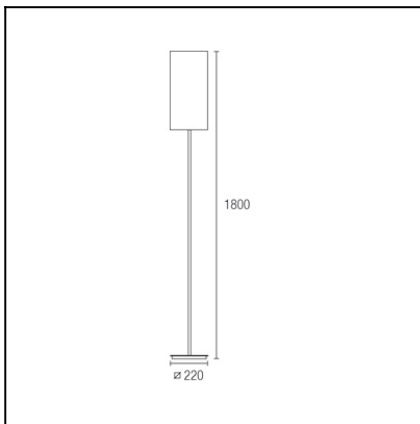

The photograph may not match the reference exactly. Please read the product description to identify the finish.



TECHNICAL CHARACTERISTICS

Type:	Table lamp
IP Protection degrees:	IP20
Lampholder:	1 x E27
Power (W):	E27 MAX 100W
Voltage / Frequency:	220-240V/50-60Hz
Units per box:	1
Net Weight (Kg):	6.6
EAN:	8435111032770

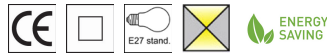

MATERIALS / FINISHES

Structure material: Steel
Structure finish: Satin nickel

Diffuser material: Fabric shade
Diffuser finish: Beige

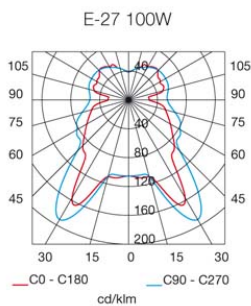

$\eta = 72,92\%$

Download photometric file .ldt / .ies

Luminaria		Ensayo		Lámpara	
Código	335-NS	Código	335-NS	Código	CLAS A CL 100
Nombre	Pie COIMBRA 100W E27 pantalla	NombrePie	COIMBRA 100W E27 tela	Número	1
Familia	- LEDS-C4	Fecha	20-07-2010	Posición	Universal
Eficiencia	72.92%	Sist. de Coorden.	C-G	Flujo Total	1360.00 lm
Valor Máximo	238.99 cd	Posición	C=45.00 G=35.00	Bisimétrico	

220mm x 220mm

Semiplanos C

180.0 ——— 0.0
 270.0 ——— 90.0

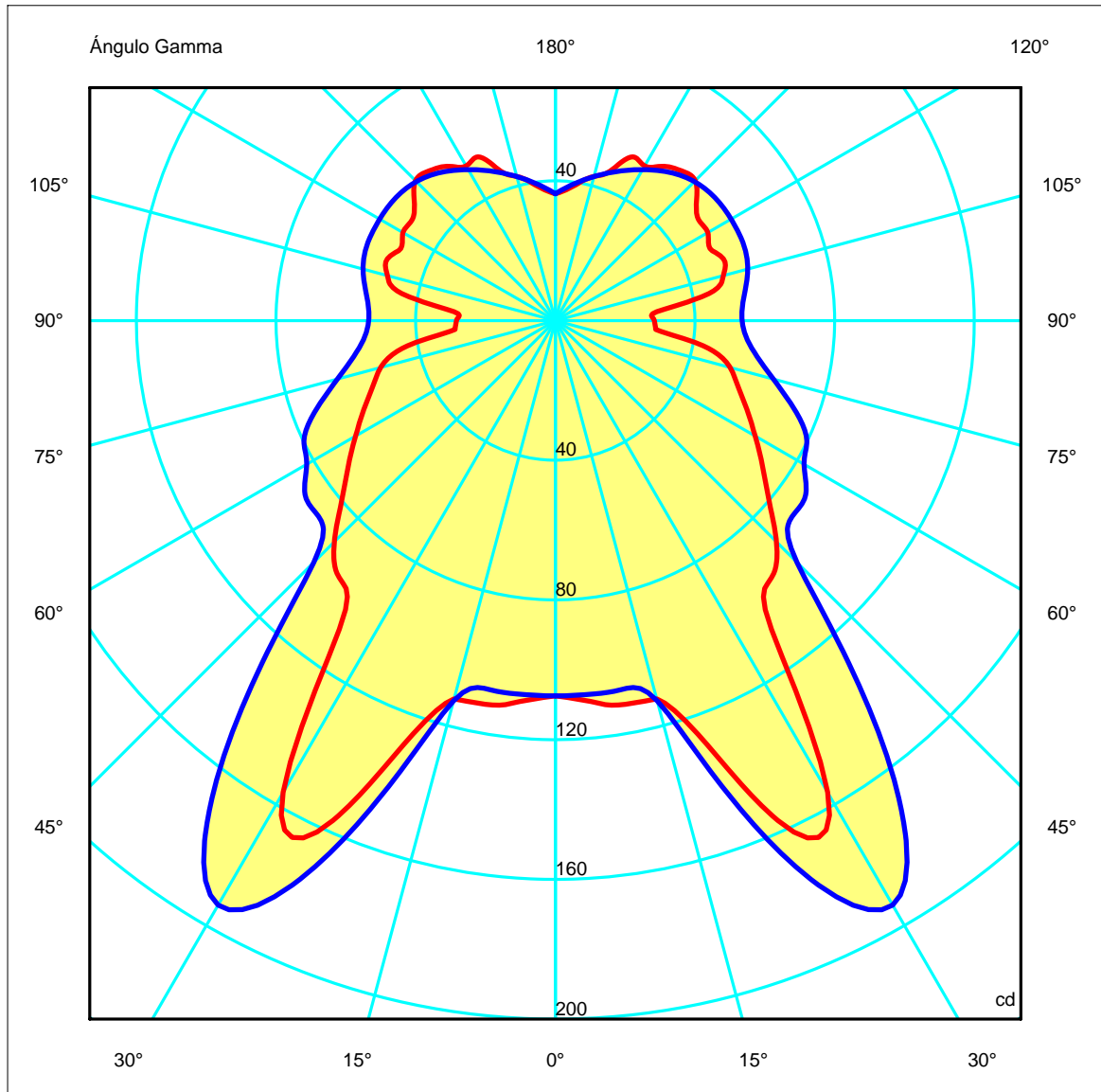
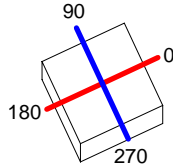

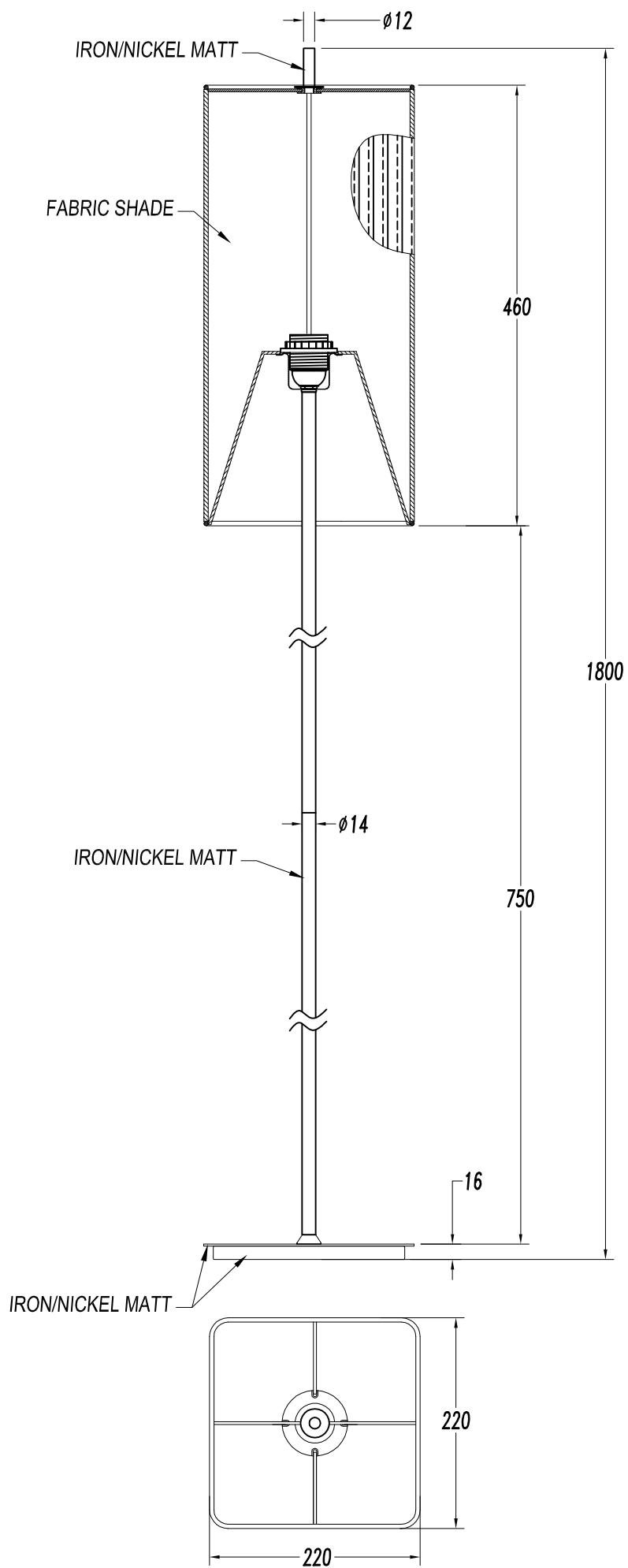

1

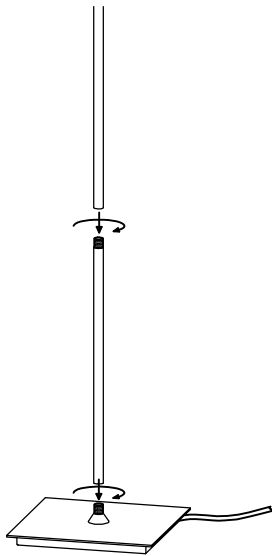

2

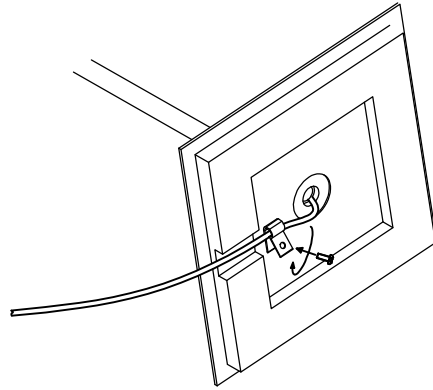

3

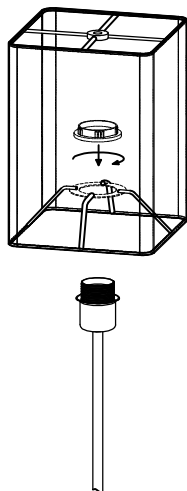

4

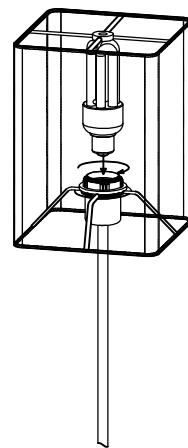

5

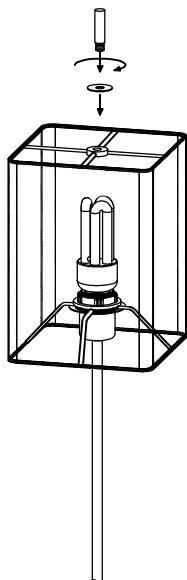

6

