

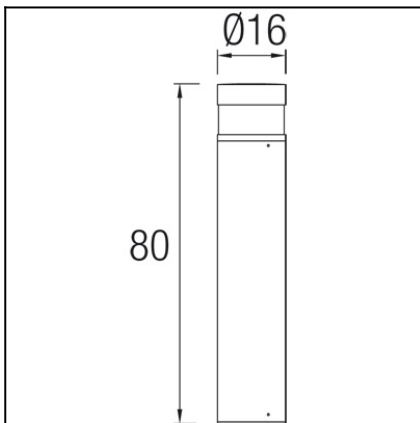

The photograph may not match the reference exactly. Please read the product description to identify the finish.



DESCRIPTION

Bollard with body produced in high grade aluminium. It comes complete with a clear polycarbonate diffuser inside and a frosted glass diffuser on the outside. Available in E-27 version for LED, compact fluorescent and halogen lamps and in HID version with 35W and 70W electronic components included. Light bulbs not included. Offered in two diameter options (16cm and 20cm) and in two finishes (light grey or dark grey).

TECHNICAL CHARACTERISTICS

Type:	Beacon
IP Protection degrees:	IP65
IK Protection degrees:	IK08
Lampholder:	1 x E27
Power (W):	E27 MAX 23W
Total power consumption (W):	23
Voltage / Frequency:	230V/50-60Hz
Warranty (Years):	2
Units per box:	2
Net Weight (Kg):	3.42
EAN:	8435111082225,00

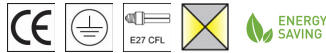

MATERIALS / FINISHES

Structure material: High purity aluminium

Diffuser material: Polycarbonate

Structure finish: Grey

Diffuser finish: Transparent

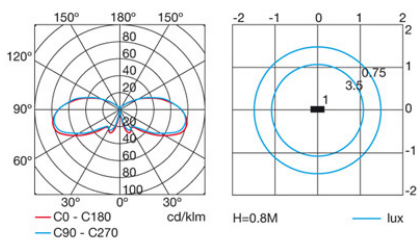

Download photometric file .ldt / .ies

Luminaria		Ensayo		Lámpara	
Código	55-9504-34-M2	Código	55-9504-34-M2	Código	PL ELECT pro23W/827
Nombre	Baliza NEWTON 23W TC-TSE opal	Nombre	Baliza NEWTON 23W TC-TSE opal	Número	1
Familia	- LEDS-C4	Fecha	05-04-2011	Posición	Universal
Rendimiento	34.42%	Sist. de Coordin.	C-G	Flujo Total	1500.00 lm
Valor Máximo	81.56 cd	Posición	C=75.00 G=80.00	Bisimétrico	
Luminaria Redonda	Diam.	160 mm	Altura	800 mm	
Área Luminosa Redonda	Diam.	160 mm	Altura	75 mm	
Área Luminosa Horizontal	0.020106 m ²		Área Emisión sobre Pl. 180°	0.012000 m ²	
Área Emisión sobre Pl. 0°	0.012000 m ²		Área Emisión sobre Pl. 270°	0.012000 m ²	
Área Emisión sobre Pl. 90°	0.012000 m ²		Área de deslumbramiento a 76°	0.016508 m ²	
Tipo de Simetría	Bisimétrico	Máximo Ángulo Gamma	Flujo de Ensayo	180	1500.00 lm
Distancia de Ensayo	6.44				
Operador	Asselum T2	Voltaje de la Fuente	Corriente de la Fuente	230.00 V	
Temperatura	20.00 °C	Corriente de la Fuente	Fotocélula	PRC	
Humedad	50.00 %				
Notas					

Lámparas de la Luminaria					
Familia	Código	Nombre	Flujo/lm	Pot.W	Cant.
PHILIPS 2005 ILCOS FBT,G,C,FSQ	PL ELECT pro23W/827	PL electr pro 23W/827 E27	1500.00	23.00	1
C.I.E.	11 31 64 64 34	D DIN 5040		B11	
F UTE	--	B NBN		BZ 10	

Diam=160mm

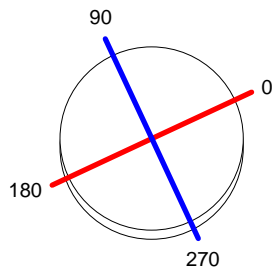

Semiplanos C

180.0 — 0.0
270.0 — 90.0

ULOR 12.48 %
DLOR 21.93 %
RN 36.27 %

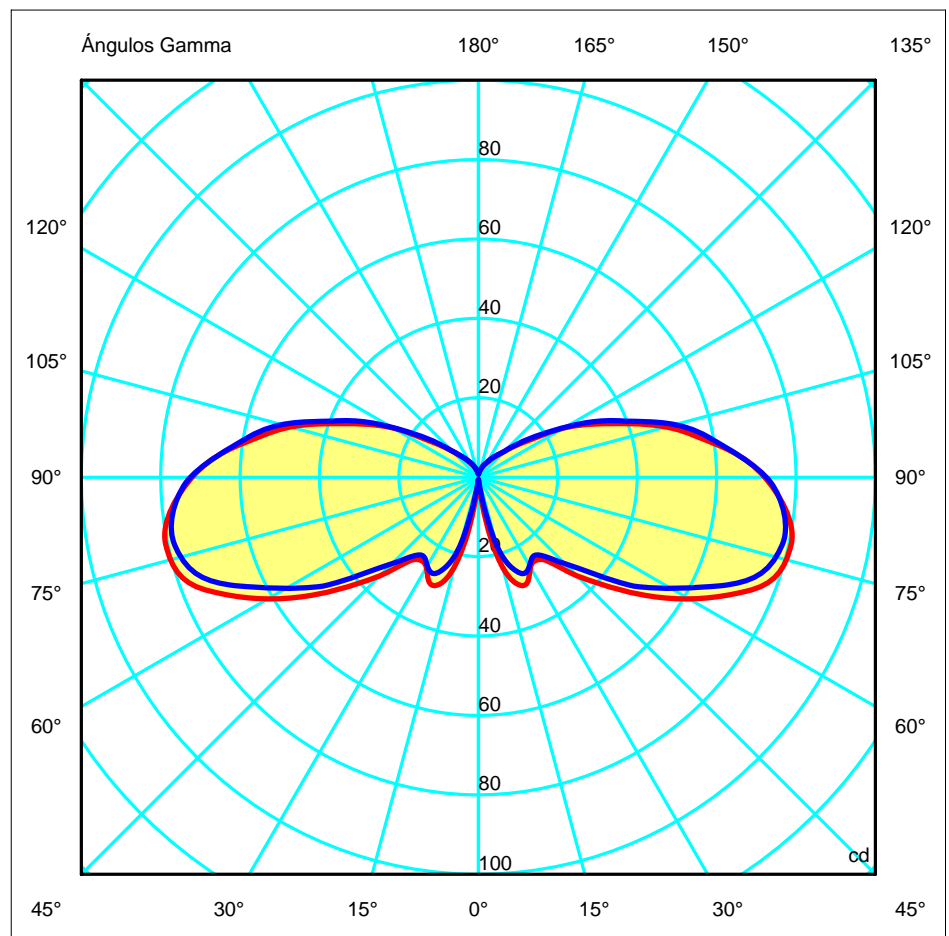

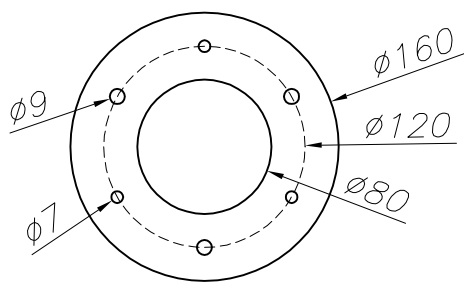
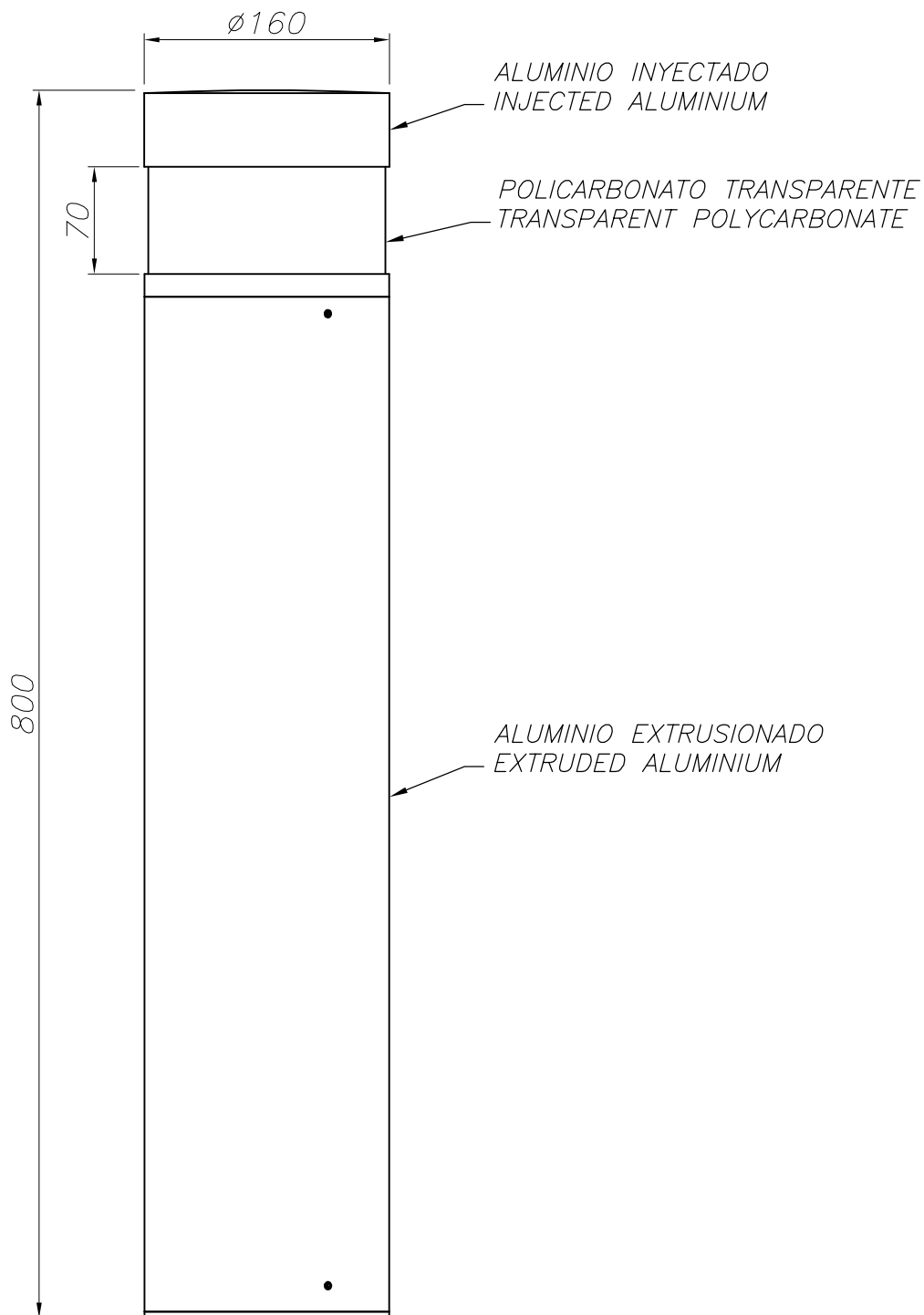

PLANTILLA DE INSTALACION
INSTALLATION TEMPLATE

