

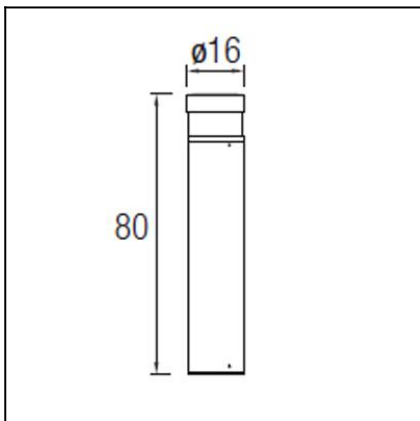

The photograph may not match the reference exactly. Please read the product description to identify the finish.



DESCRIPTION

Bollard with body produced in high grade aluminium. It comes complete with a clear polycarbonate diffuser inside and a frosted glass diffuser on the outside. Available in E-27 version for LED, compact fluorescent and halogen lamps and in HID version with 35W and 70W electronic components included. Light bulbs not included. Offered in two diameter options (16cm and 20cm) and in two finishes (light grey or dark grey).

TECHNICAL CHARACTERISTICS

Type:	Beacon
IP Protection degrees:	IP65
IK Protection degrees:	IK08
Lampholder:	1 x G8.5
Power (W):	G8.5 35W
Voltage / Frequency:	230V/50Hz
Warranty (Years):	2
Units per box:	2
Net Weight (Kg):	4.72
EAN:	8435111082102,00

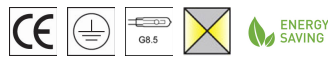

MATERIALS / FINISHES

Structure material:	High purity aluminium	Diffuser material:	Polycarbonate
Structure finish:	Urban grey	Diffuser finish:	Transparent

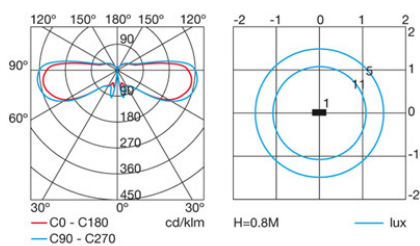

GEAR

Gear included: Yes, Magnetic

Download photometric file .ldt / .ies

Luminaria		Ensayo		Lámpara	
Código	55-9505-34-M2	Código	55-9505-34-M2	Código	CDM-TC35W/830
Nombre	Baliza NEWTON 35W CDM-TC opal	Nombre	Baliza NEWTON 35W CDM-TC opal	Número	1
Familia	- LEDS-C4	Fecha	05-04-2011	Posición	Universal
Rendimiento	47.48%	Sist. de Coordin.	C-G	Flujo Total	3300.00 lm
Valor Máximo	278.53 cd	Posición	C=90.00 G=80.00		Bisimétrico
Luminaria Redonda	Diam. 160 mm	Altura	800 mm		
Área Luminosa Redonda	Diam. 160 mm	Altura	75 mm		
Área Luminosa Horizontal	0.020106 m ²	Área Emisión sobre Pl. 180°	0.012000 m ²		
Área Emisión sobre Pl. 0°	0.012000 m ²	Área Emisión sobre Pl. 270°	0.012000 m ²		
Área Emisión sobre Pl. 90°	0.012000 m ²	Área de deslumbramiento a 76°	0.016508 m ²		
Tipo de Simetría	Bisimétrico	Máximo Ángulo Gamma	180		
Distancia de Ensayo	6.44	Flujo de Ensayo	3300.00 lm		
Operador	Asselum T2	Voltaje de la Fuente	230.00 V		
Temperatura	20.00 °C	Corriente de la Fuente			
Humedad	50.00 %	Fotocélula	PRC		
Notas					

Lámparas de la Luminaria					
Familia	Código	Nombre	Flujo/lm	Pot.W	Cant.
PHILIPS 2005 ILCOS MD,MT,ME,MC	CDM-TC35W/830	MASTER col CDM-TC 35W/830	3300.00	38.00	1
C.I.E.	9 28 62 69 47	D DIN 5040			
F UTE	--	B NBN		B11	BZ 10

Diam=160mm

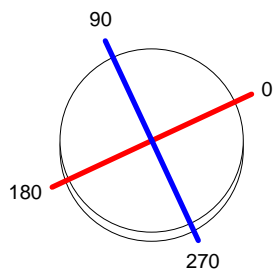

Semiplanos C

180.0 — 0.0
270.0 — 90.0

ULOR 14.61 %
DLOR 32.87 %
RN 30.77 %

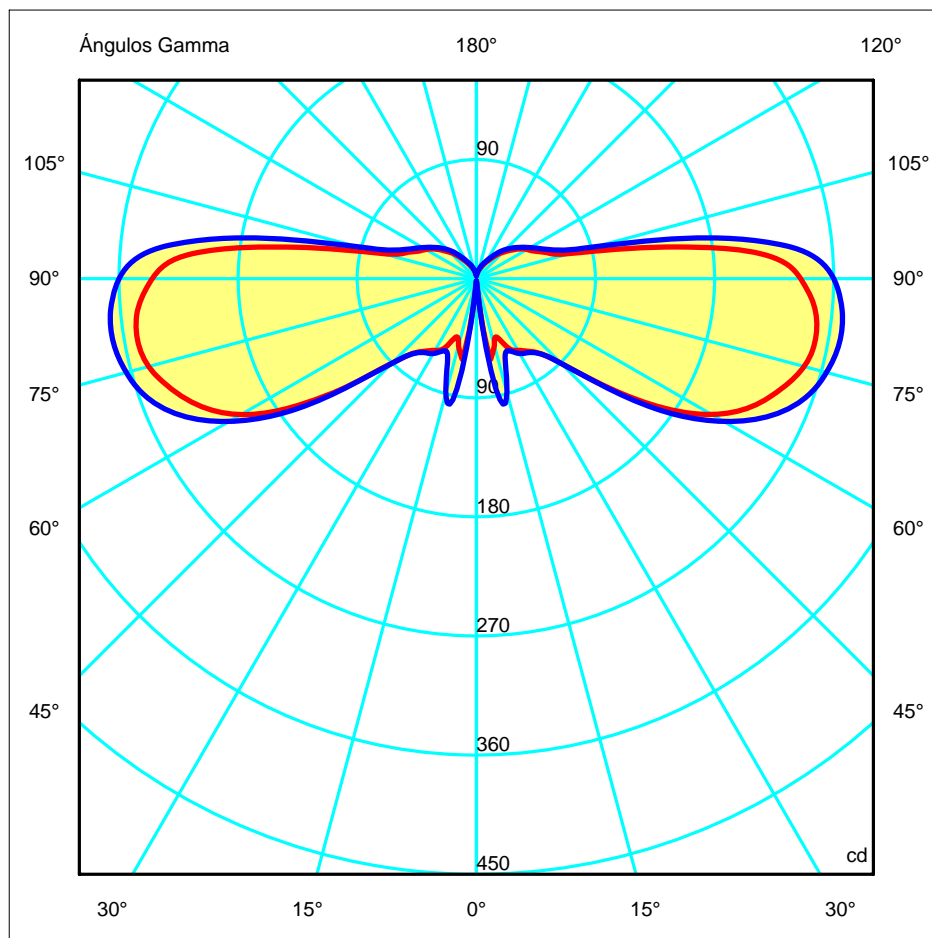

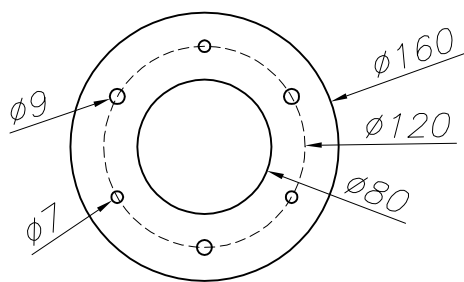
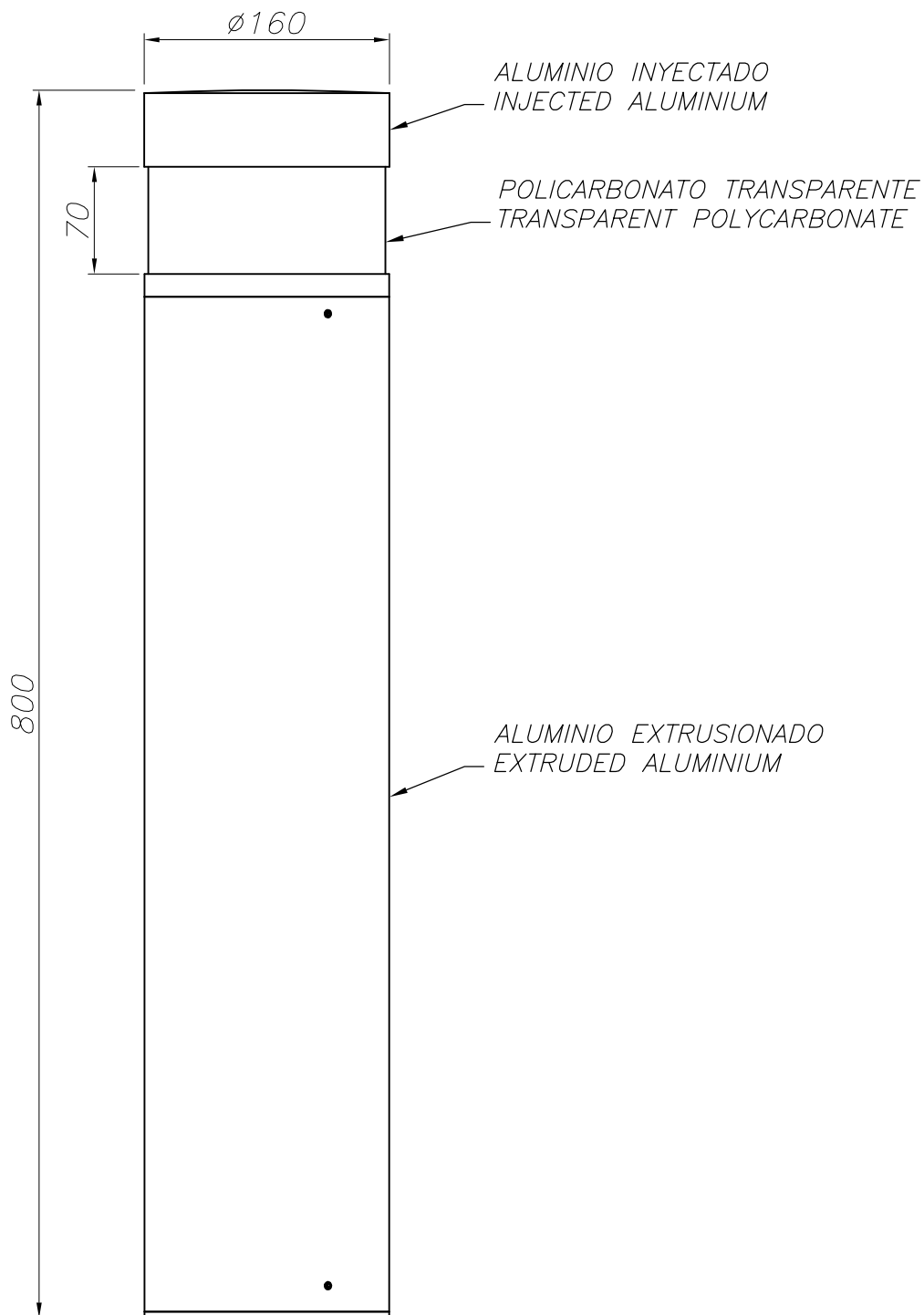

PLANTILLA DE INSTALACION
INSTALLATION TEMPLATE

