

RGB CONTROLLERS WITH REMOTE CONTROL

71-0019-00-00

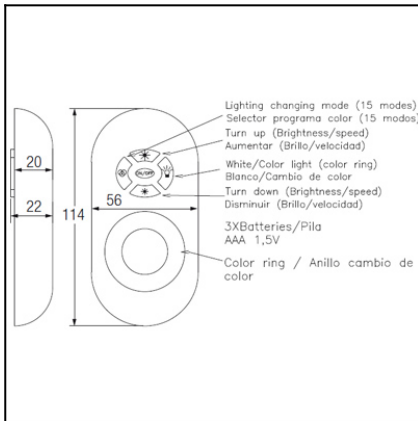

The photograph may not match the reference exactly. Please read the product description to identify the finish.



DESCRIPTION

LED stripe controller with 15 pre-set RGB programmes, 64-colour independent control ring, change of speed for programmes with colour sequence and change of light intensity for monochrome programmes. It incorporates a radio-frequency remote control.

TECHNICAL CHARACTERISTICS

| | |
|------------------------|------------------|
| Type: | Accessory |
| IP Protection degrees: | IP20 |
| Voltage / Frequency: | 12/24 VDC |
| Warranty (Years): | 2 |
| Units per box: | 100 |
| Net Weight (Kg): | 0.13 |
| EAN: | 8435111090022,00 |



MATERIALS / FINISHES

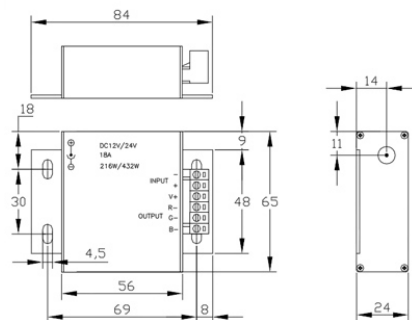

Download photometric file .ldt /.ies

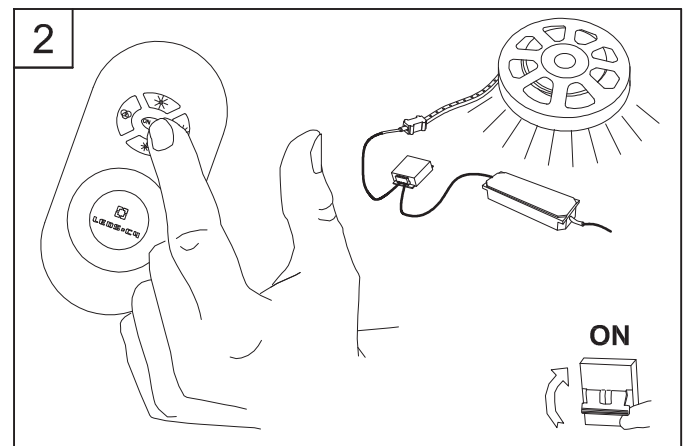
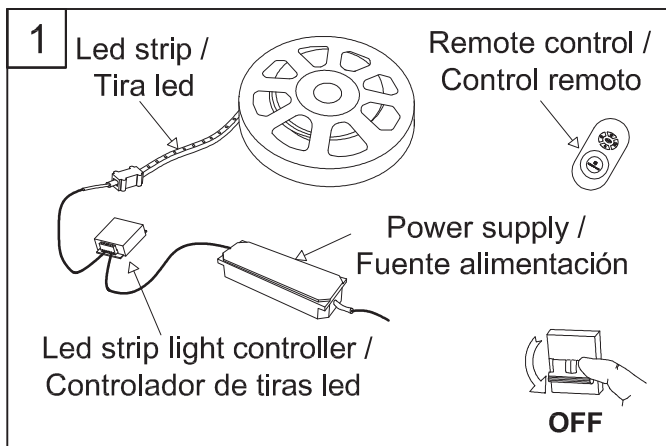
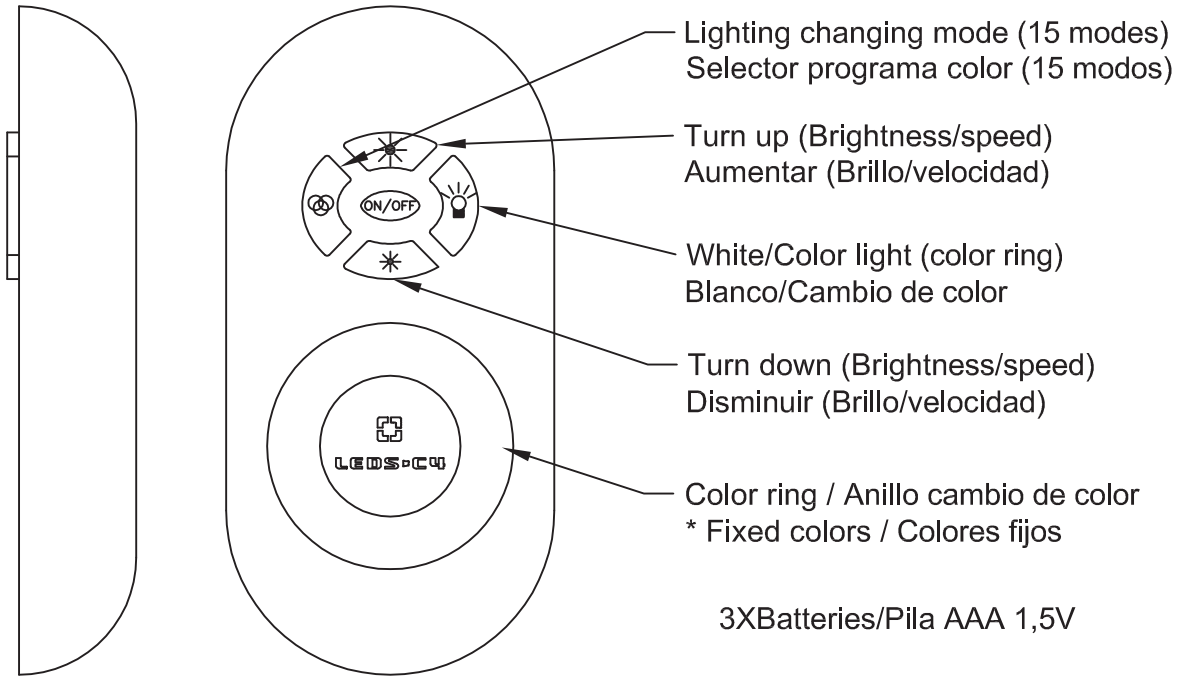

RGB programs / Programas RGB

1- Auto color changing / Cambio color auto

2- (RGB) Red-Green-Blue / Rojo-Verde-Azul

3- R-G-B-Yellow-Cyan-Purple-White /
R-G-B-Amarillo-Cian-Lila-Blanco

4- Auto RGB changing / Cambio RGB auto

5- Auto color changing 2 / Cambio color auto 2

6- Intermittent red / Rojo intermitente

7- Intermittent blue / Azul intermitente

8- Intermittent purple / Lila intermitente

9- Intermittent green / Verde intermitente

10- Intermittent yellow / Amarillo intermitente

11- Intermittent cyan / Cian intermitente

12 Intermittent white / Blanco intermitente

13- Red-Blue / Rojo-Azul

14- Green-Blue / Verde-Azul

15- Red-Green / Rojo-Verde

* For fixed colors use the control color ring
(64 independent colour) / Para colores fijos utilizar el
anillo de cambio de color (64 colores independientes).

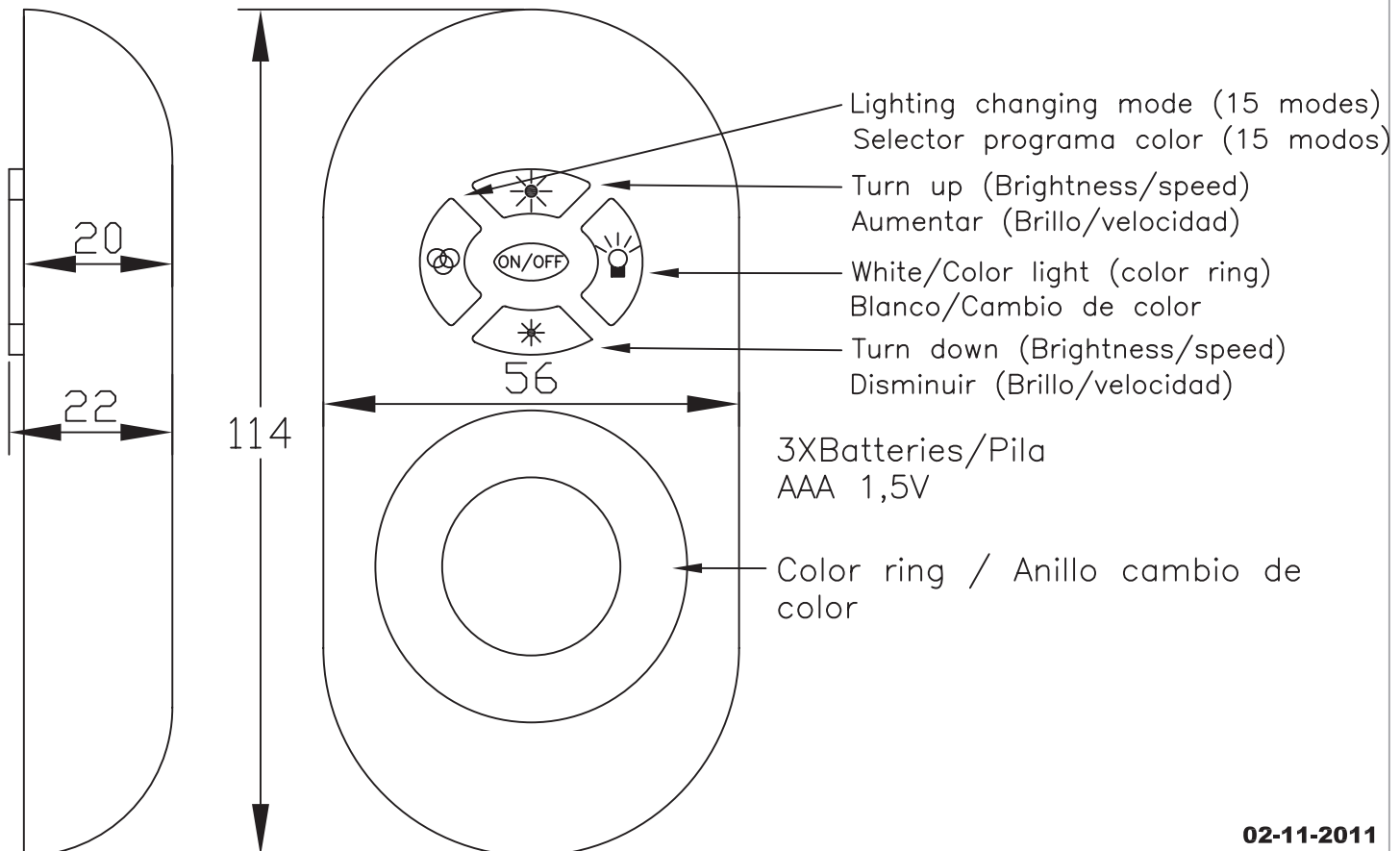
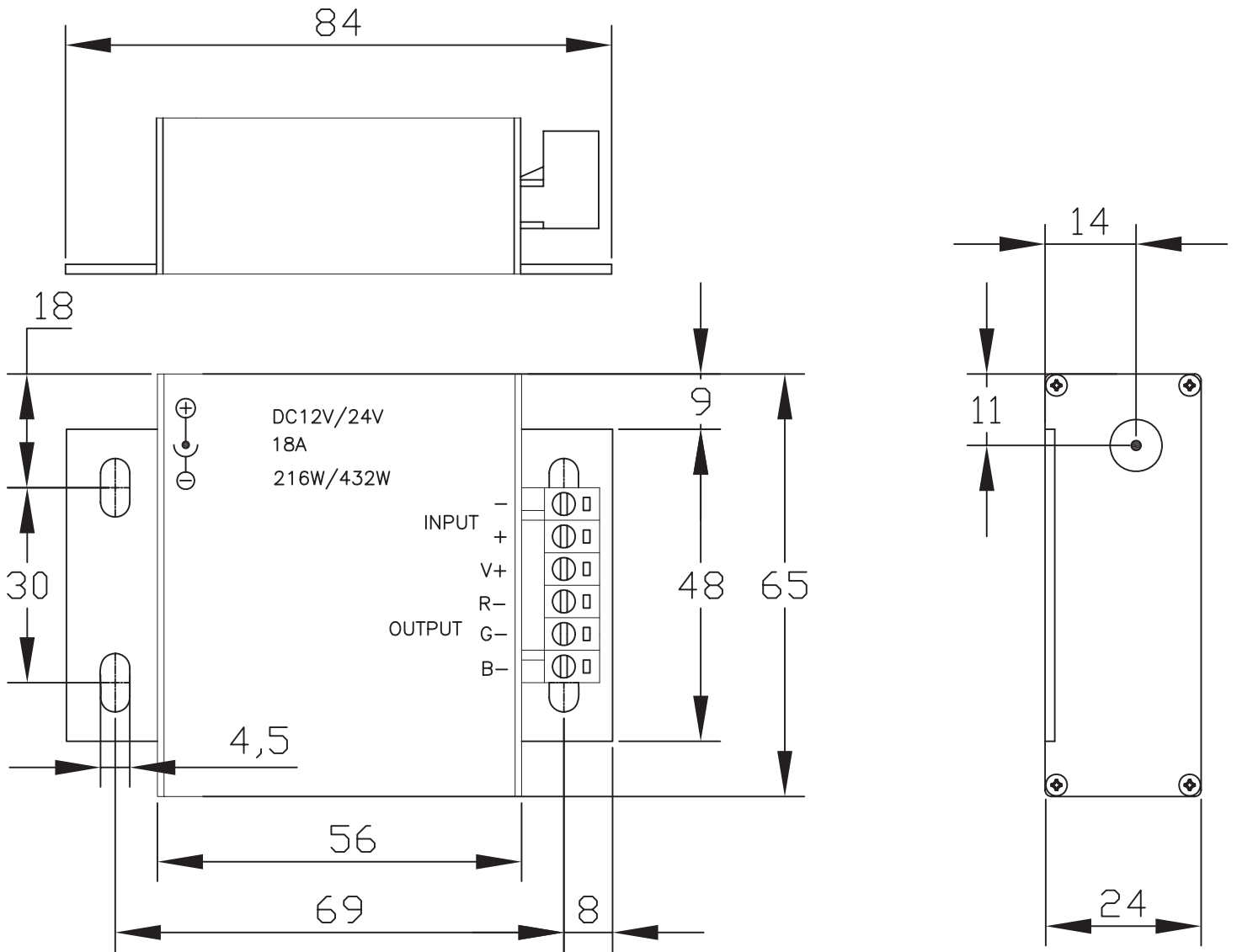

INPUT DC12/24VDC
12VDC – MAX.216W
24VDC – MAX.432W

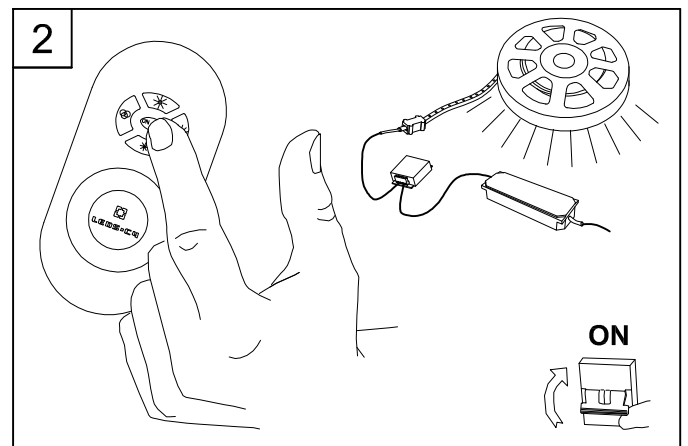
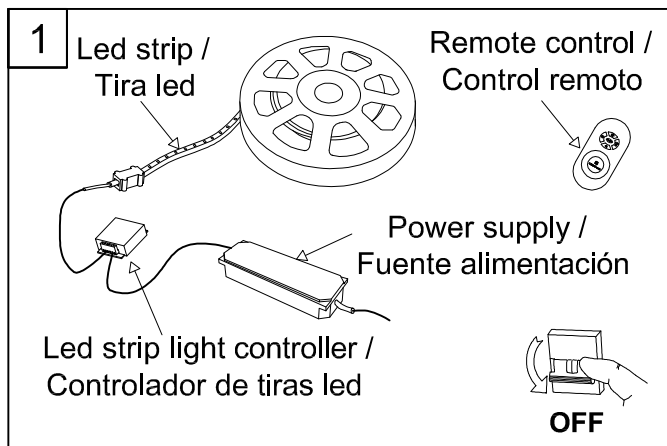
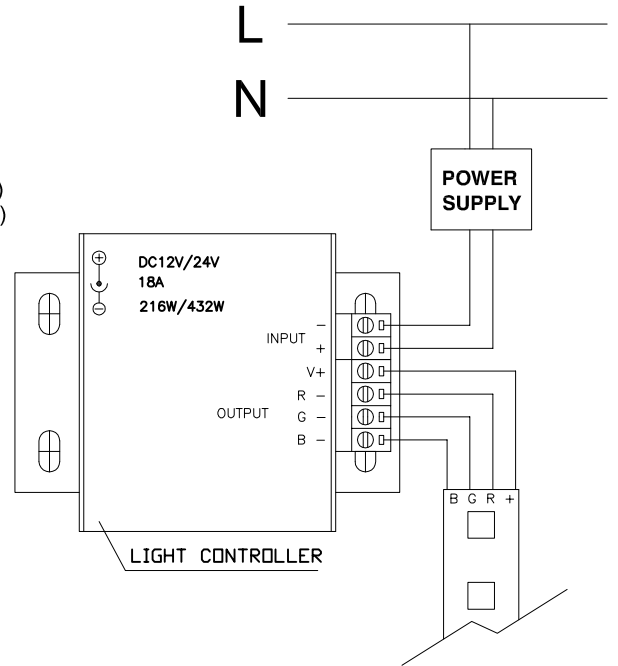
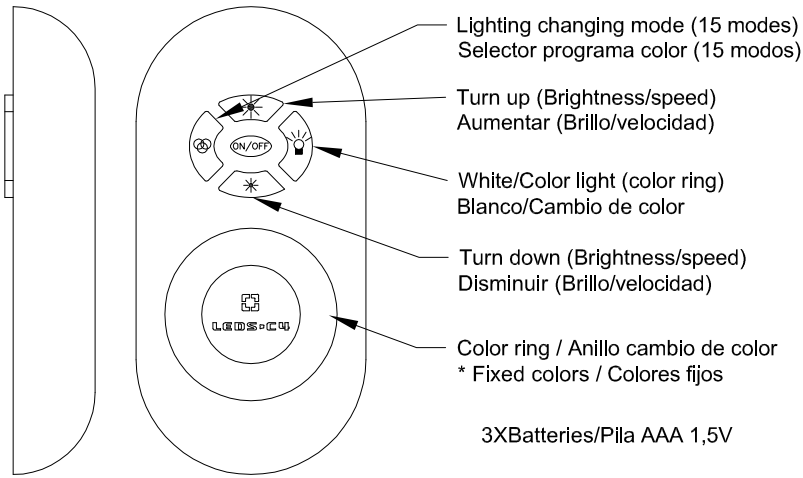

RGB programs / Programas RGB

1- Auto color changing / Cambio color auto

2- (RGB) Red-Green-Blue / Rojo-Verde-Azul

3- R-G-B-Yellow-Cyan-Purple-White /
R-G-B-Amarillo-Cian-Lila-Blanco

4- Auto RGB changing / Cambio RGB auto

5- Auto color changing 2 / Cambio color auto 2

6- Intermittent red / Rojo intermitente

7- Intermittent blue / Azul intermitente

8- Intermittent purple / Lila intermitente

9- Intermittent green / Verde intermitente

10- Intermittent yellow / Amarillo intermitente

11- Intermittent cyan / Cian intermitente

12 Intermittent white / Blanco intermitente

13- Red-Blue / Rojo-Azul

14- Green-Blue / Verde-Azul

15- Red-Green / Rojo-Verde

* For fixed colors use the control color ring
(64 independent colour) / Para colores fijos utilizar el
anillo de cambio de color (64 colores independientes).