

The photograph may not match the reference exactly. Please read the product description to identify the finish.

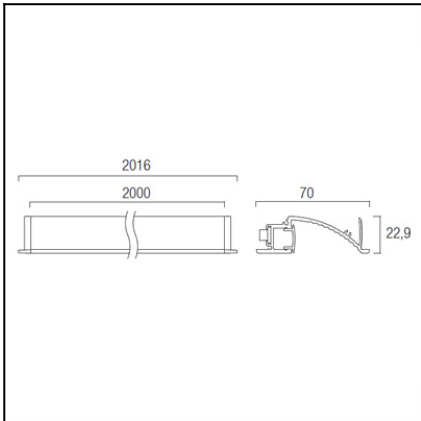

Download photometric file .ldt /.ies

TECHNICAL CHARACTERISTICS

Type:	Accessory
IP Protection degrees:	IP20
Warranty (Years):	2
Units per box:	1
Net Weight (Kg):	1.41
EAN:	0,00



MATERIALS / FINISHES

Structure material:	Anodized aluminium Methacrylate	Diffuser material:	Polycarbonate
	Grey	Diffuser finish:	Tinted

