

MANDO CONTROLADORS DMX

71-4666-00-00

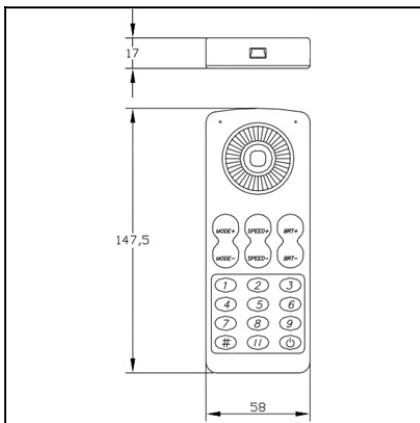

The photograph may not match the reference exactly. Please read the product description to identify the finish.



DESCRIPTION

Radio frequency remote control for managing the RGB 71-4662-00-00 and 71-4663-00-00 controllers. It incorporates a touchscreen which allows the user to independently control 64 colours, manage the 16 programmes of the controllers and change speeds and lig

TECHNICAL CHARACTERISTICS

| | |
|------------------------|------------------|
| Type: | Accessory |
| IP Protection degrees: | IP20 |
| Power (W): | 64 COLORS |
| Warranty (Years): | 2 |
| Units per box: | 20 |
| Net Weight (Kg): | 0.13 |
| EAN: | 8435111084861,00 |



MATERIALS / FINISHES

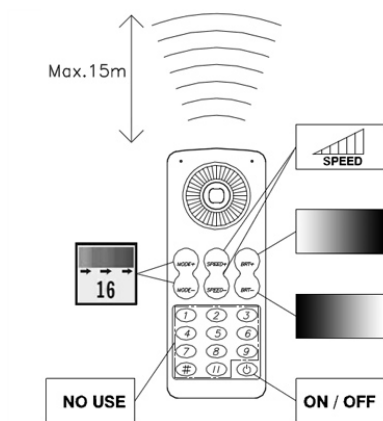

Download photometric file .ldt / .ies

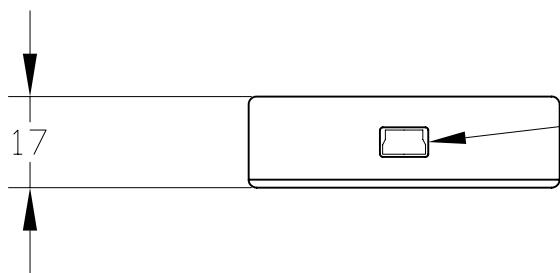

ENTRY microUSB
Entrada microUSB

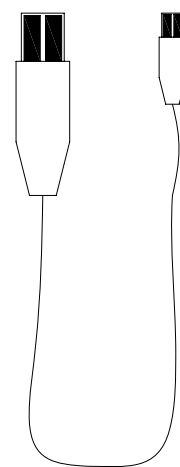
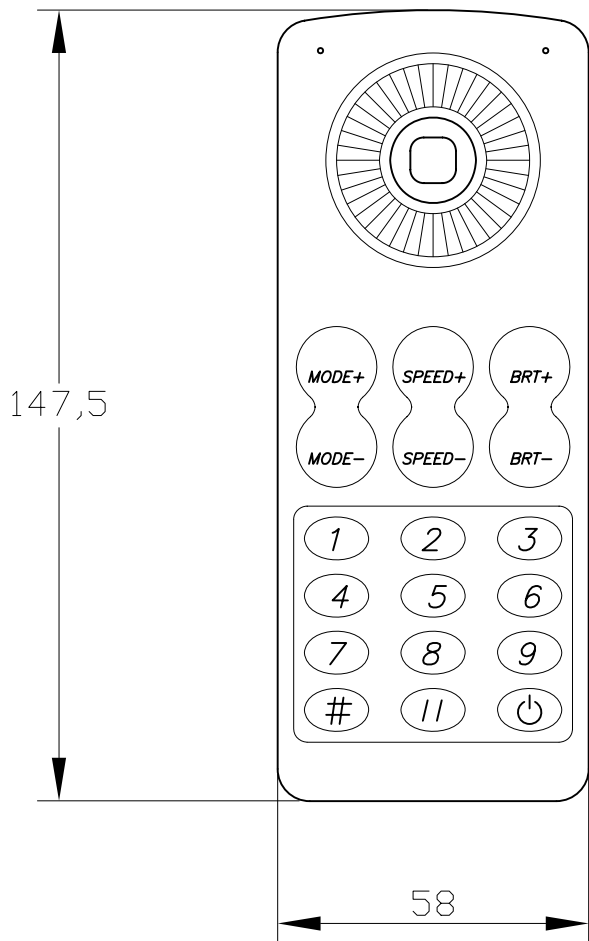

Wire L=830mm

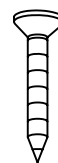
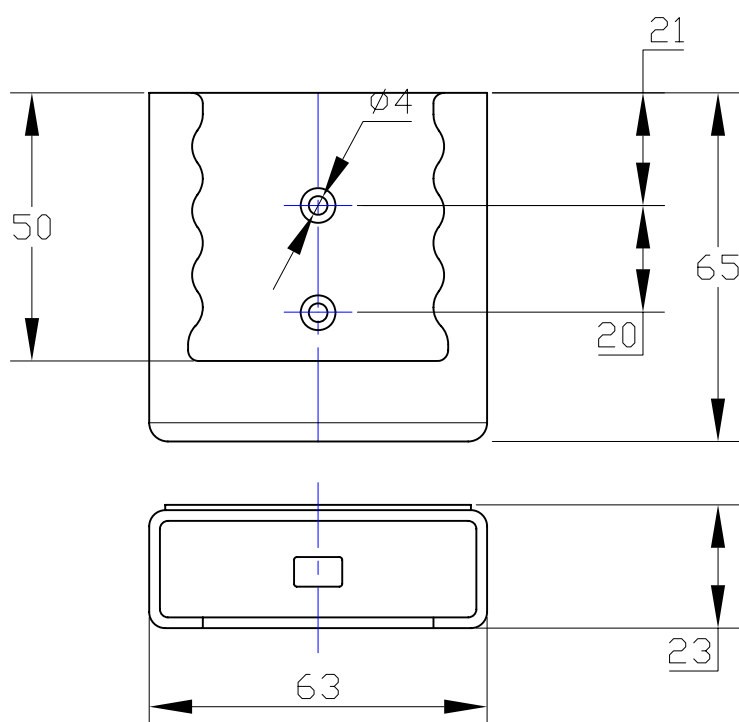

x 2



x 2

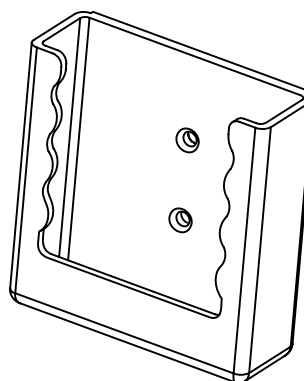

71-4662-00-00

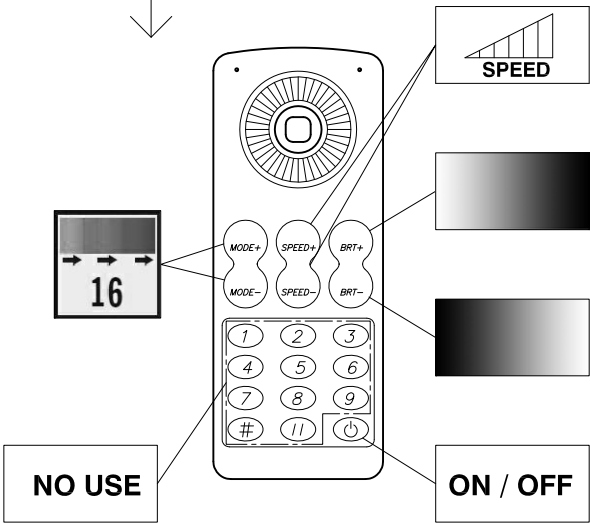
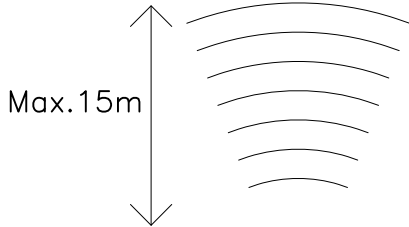
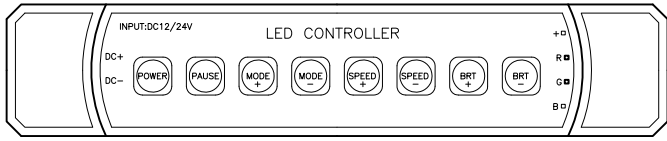

71-4666-00-00

71-4663-00-00

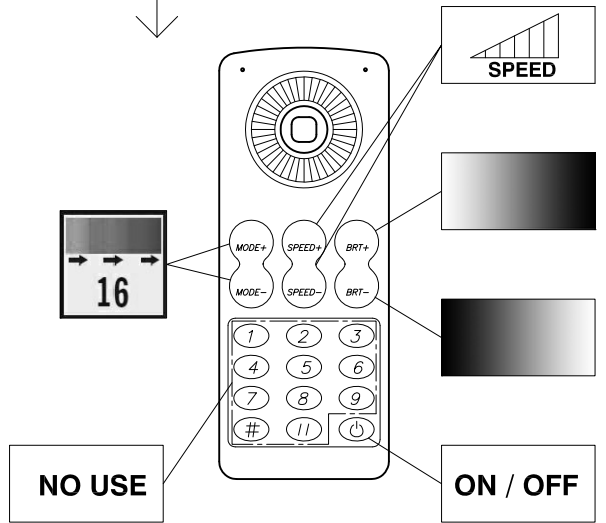
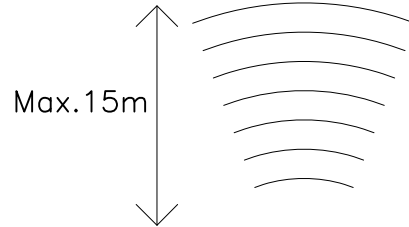
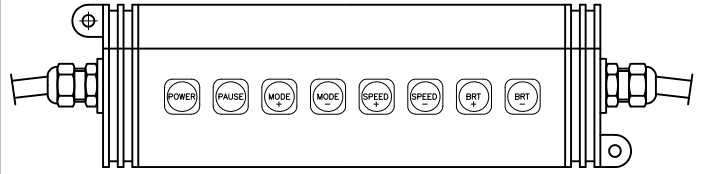

71-4666-00-00

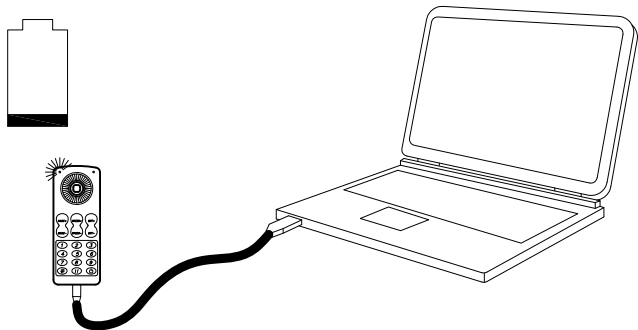

4h on

