

COLUMNA SQUADRA 6M

81-4531-BP-AV

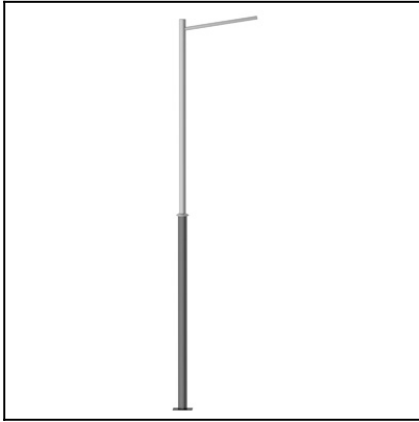

The photograph may not match the reference exactly. Please read the product description to identify the finish.

Download photometric file .ldt /.ies

TECHNICAL CHARACTERISTICS

Type:	Column
IK Protection degrees:	IK10
Warranty (Years):	2
Units per box:	1
Net Weight (Kg):	53
EAN:	8435111083161,00



MATERIALS / FINISHES

Structure material: S-235-JR hot-dipped galvanized steel

Structure finish: Baked-on black forge

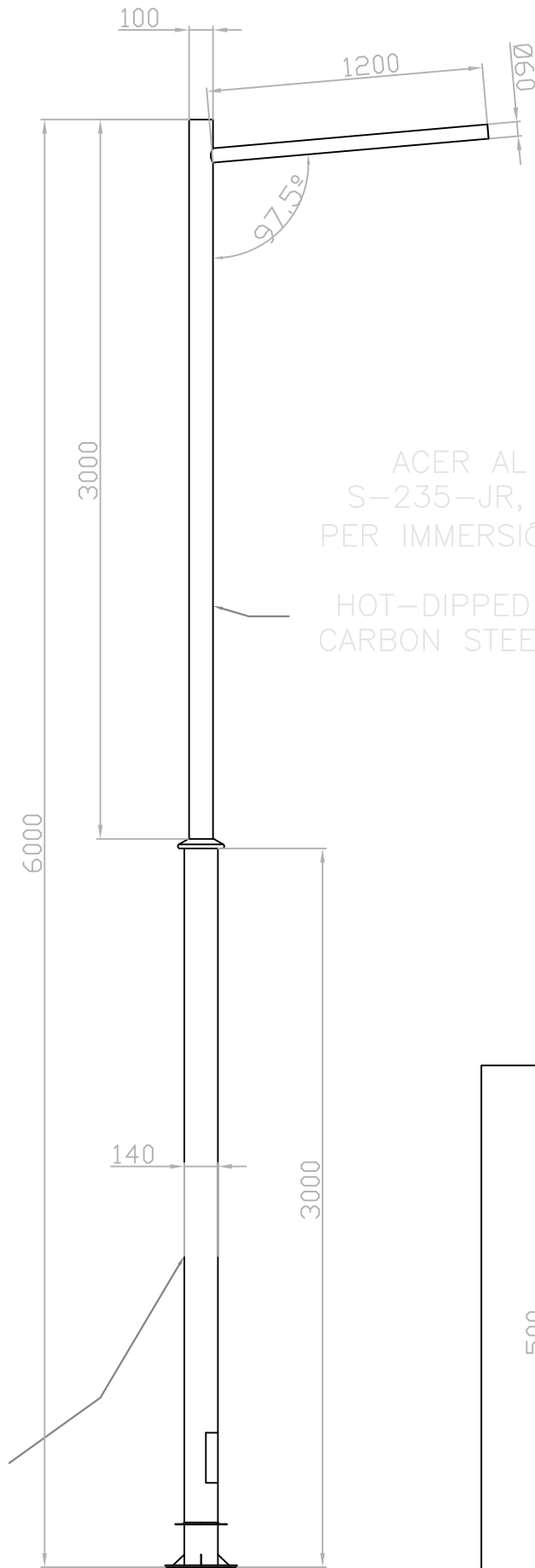
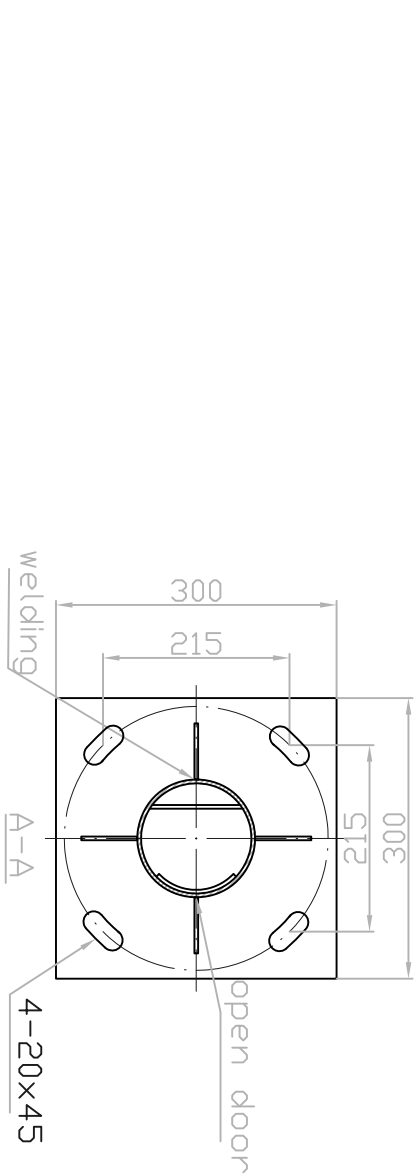

ACER AL CARBONI
S-235-JR, GALVANIZAT
PER IMMERSIÓ EN CALENT.

HOT-DIPPED GALVANISED
CARBON STEEL S-235-JR.

ACER AL CARBONI
S-235-JR, GALVANIZAT
PER IMMERSIÓ EN CALENT
PINTAT EN NEGRE FORJA.

HOT-DIPPED GALVANISED
CARBON STEEL S-235-JR
PAINTED IN BLACK FORGE.

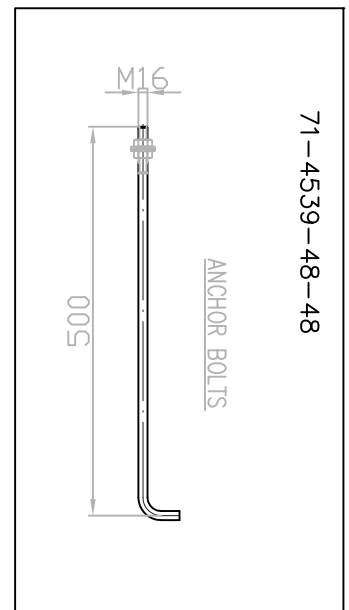

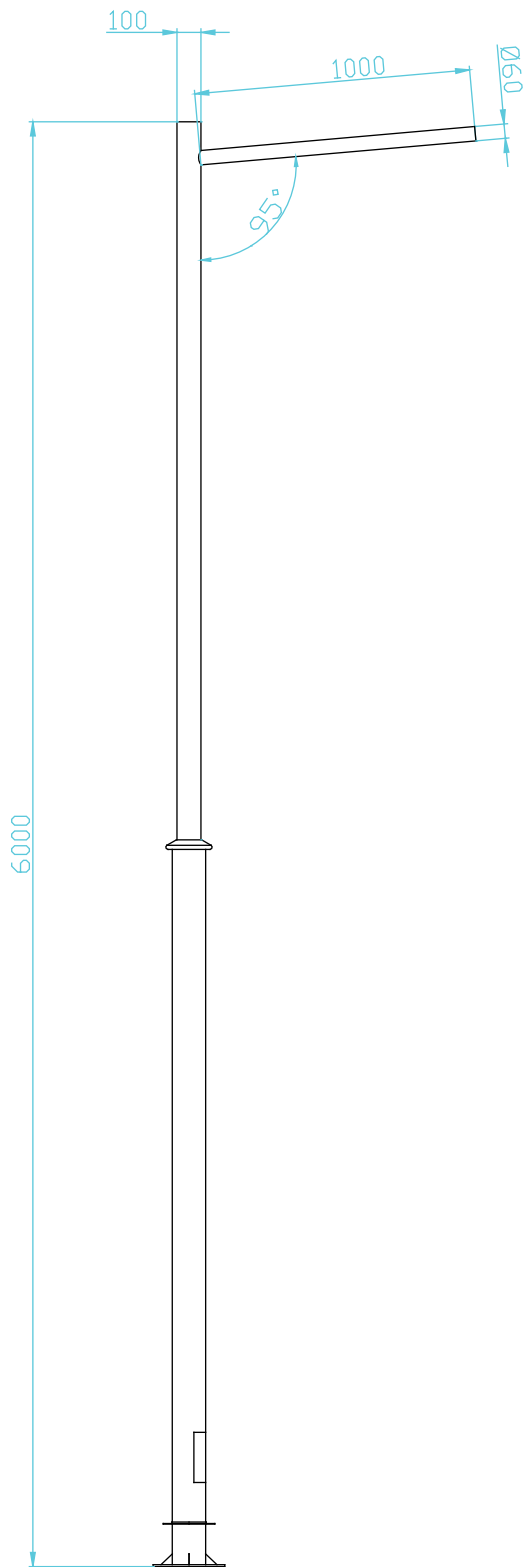

COLUMNA / COLUMN
81-4531-BP-AV

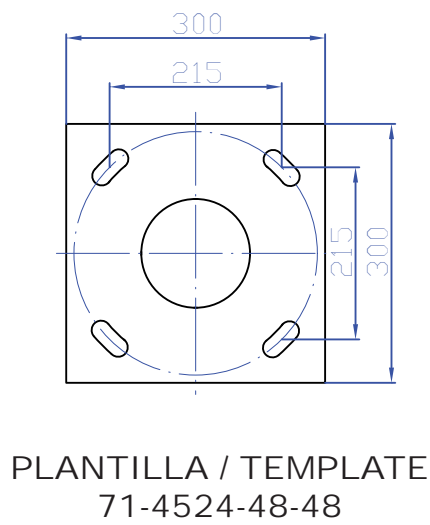
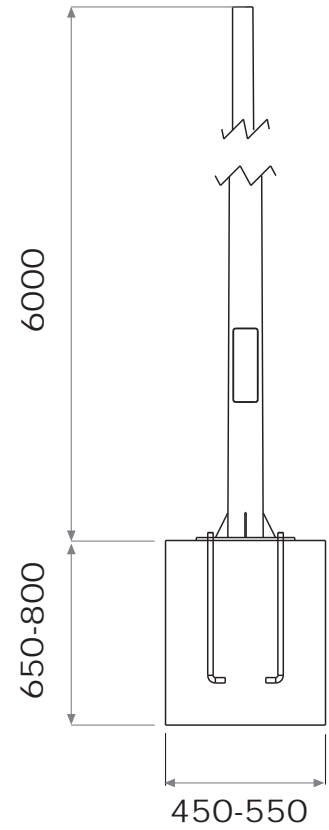

PLANTILLA / TEMPLATE
71-4524-48-48

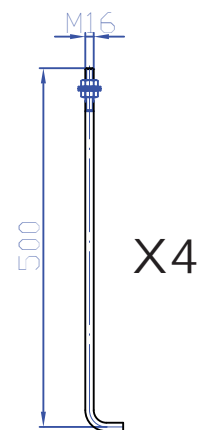

PERNO / ANCHOR BOLT
71-4539-48-48