

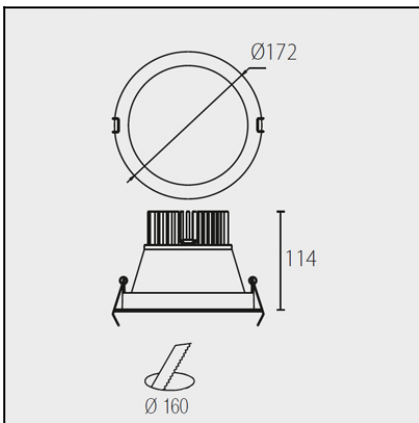

The photograph may not match the reference exactly. Please read the product description to identify the finish.



DESCRIPTION

Group of high performance LED downlights, ideal for replacing 2x18W and 2x26W compact fluorescent downlights. Steel plate casing and springs, injected aluminium surround, aluminium passive disperser and opal PMMA diffuser. Available in square and round versions both in two wattages, two sizes and two finishes (white or grey). High protection against the infiltration of solid particles and liquids. The springs included with the unit allow it to be installed on ceilings of any thickness.

TECHNICAL CHARACTERISTICS

Type:	Downlight
IP Protection degrees:	IP54
Bulb:	18 x LED Cree. Warm White - 3000K
Power (W):	39
CRI:	80
Angle Óptiques:	80°
Voltage / Frequency:	1900mA
Warranty (Years):	3
Option to extend the guarantee:	Yes, 5 years
Units per box:	20
Net Weight (Kg):	0.585
EAN:	8,43511E+12

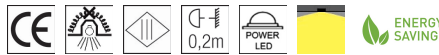

MATERIALS / FINISHES

Structure material: Aluminium

Diffuser material: UVA methacrylate

Structure finish: Grey

Diffuser finish: Tinted

GEAR

Necessary equipment not included. For more information check website / catalogs / sales organization.

Download photometric file .ldt / .ies

Max. 39W Blanco cálido / Warm white 1900mA

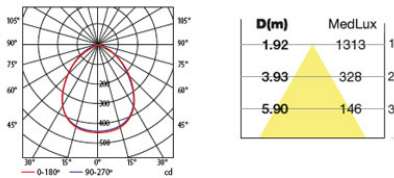

Report No.: 008

Test Time: 2012-09-03 11:11

Luminaire Property

Luminaire Category: 90-0714-14/N3-M3
 Luminaire Manufacturer: Leds-C4
 Lamp Description: XBD-7C4-Q4
 Lumens per Lamp: 147.4
 Luminous Width (mm): 140
 Voltage: 19.8 V
 Power: 37.60 W

Luminaire Description: EQUAL
 Lamp Catalog: LED
 Number of Lamps: 18
 Luminous Length (mm): 140
 Luminous Height (mm): 141
 Current: 1.9 A
 Power Factor: 1.000

Photometric Results

CIE Class: Direct
 Measurement Flux: 2387.3 lm
 Downward Ratio: 89.98%
 Luminaire Efficacy Rating (LER): 63
 Max. Intensity: 1242.14 cd

Total Rated Lamp Lumens: 2653.2 lm
 Efficiency: 89.98%
 Upward Ratio: 0.00%
 Central Intensity: 1241.49 cd
 Pos of Max. Intensity: H0 V2

Picture Of Luminaire



Luminous Intensity Distribution Curve

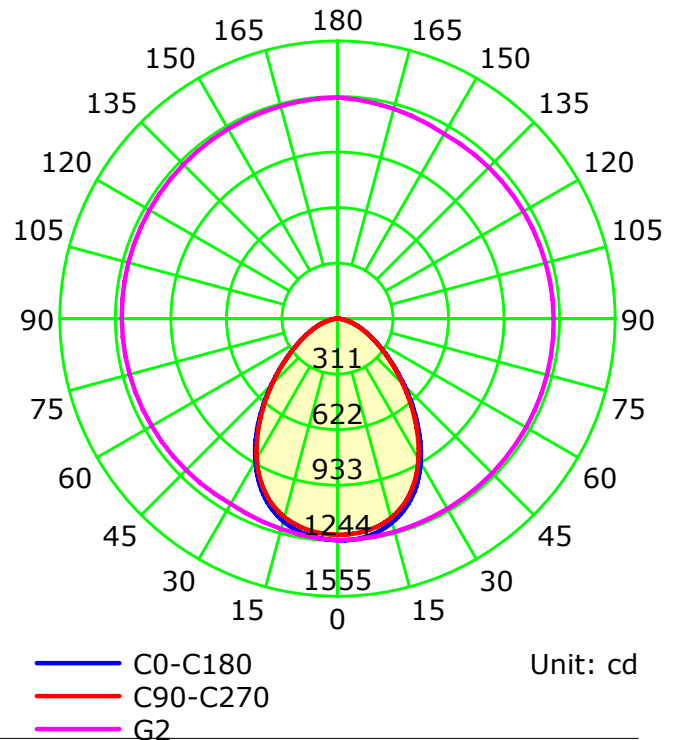

Test Type: TYPE C
 Temperature: 27

Test Device: GPM-1800
 Distance: 10.158 m
 Humidity: 48
 Inspector:

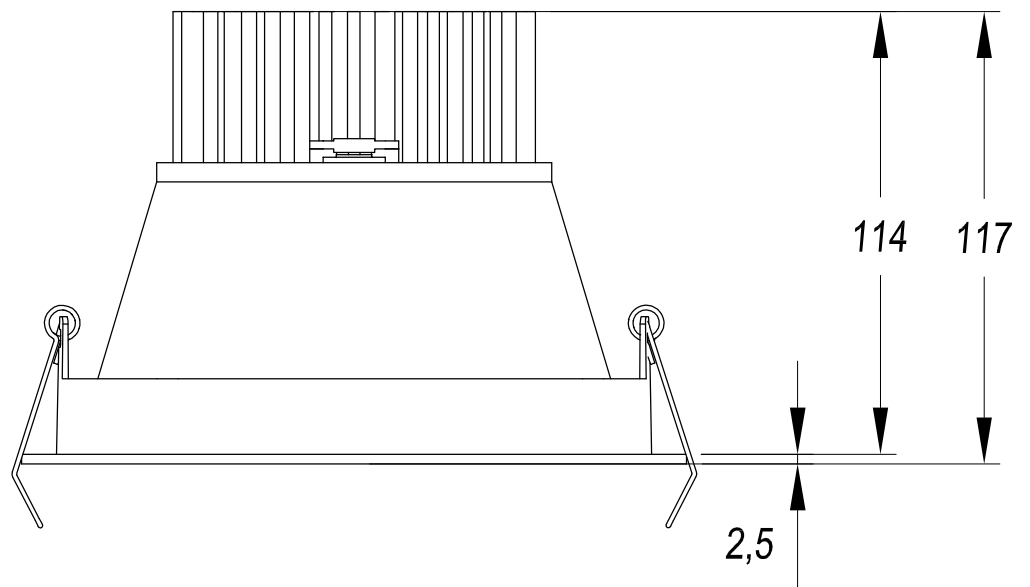
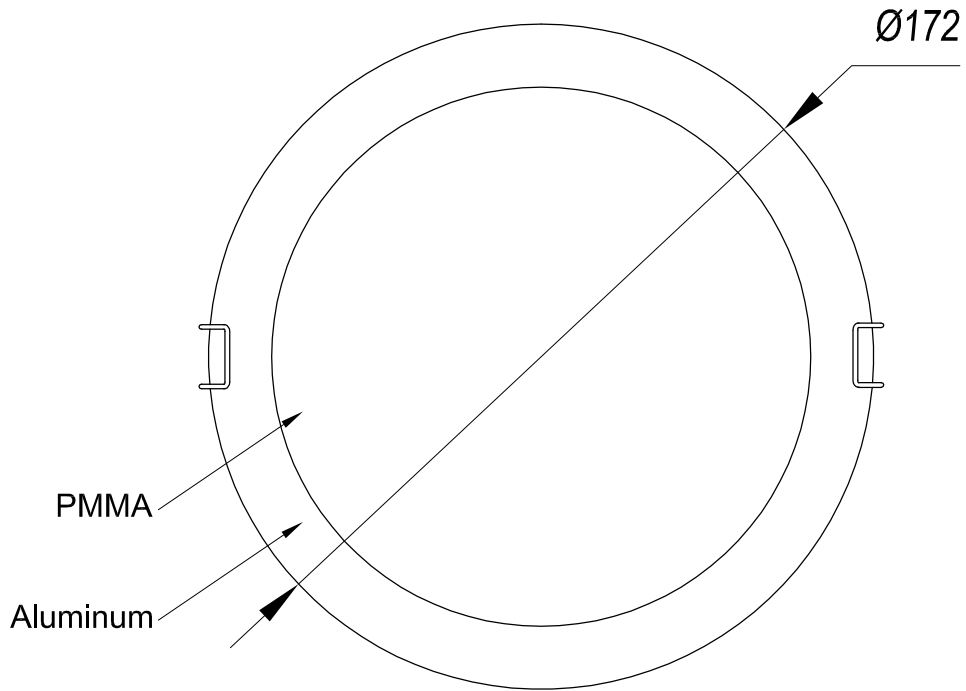

1

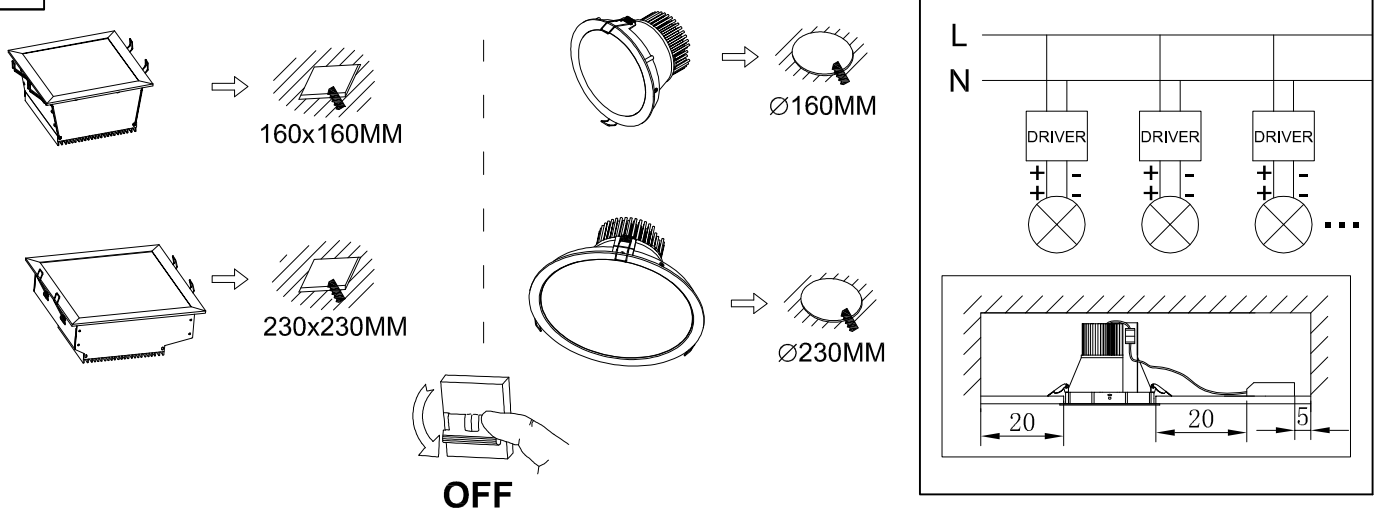

2

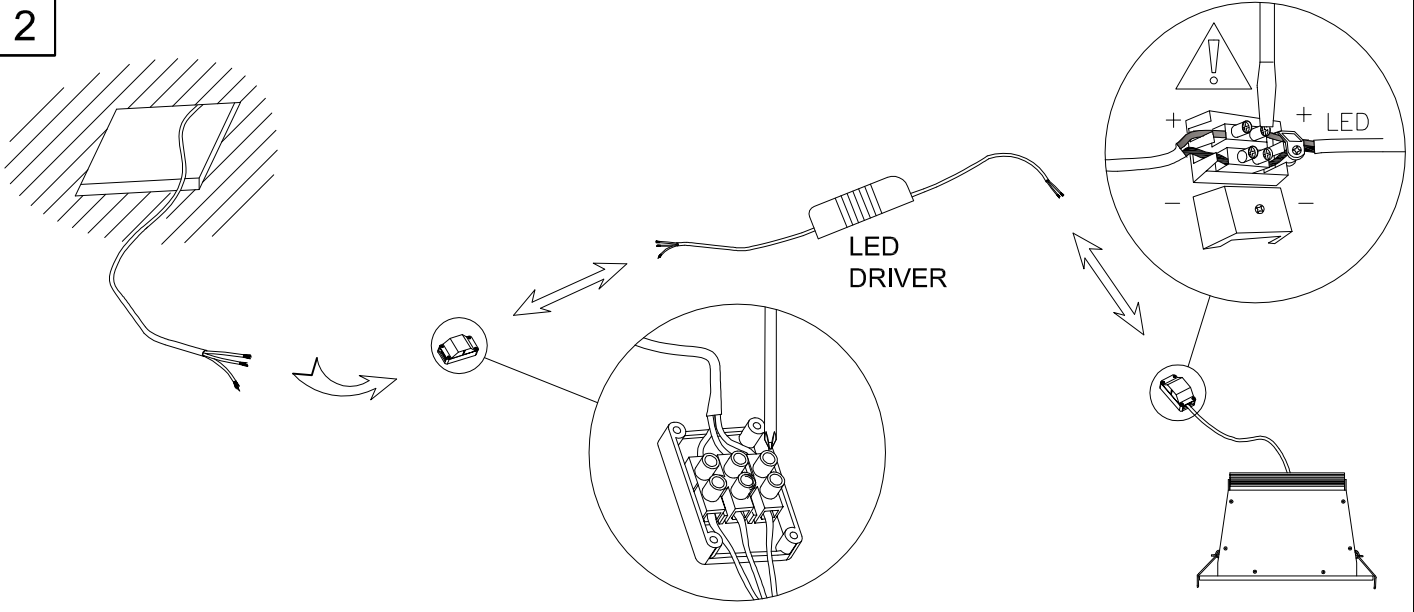

3

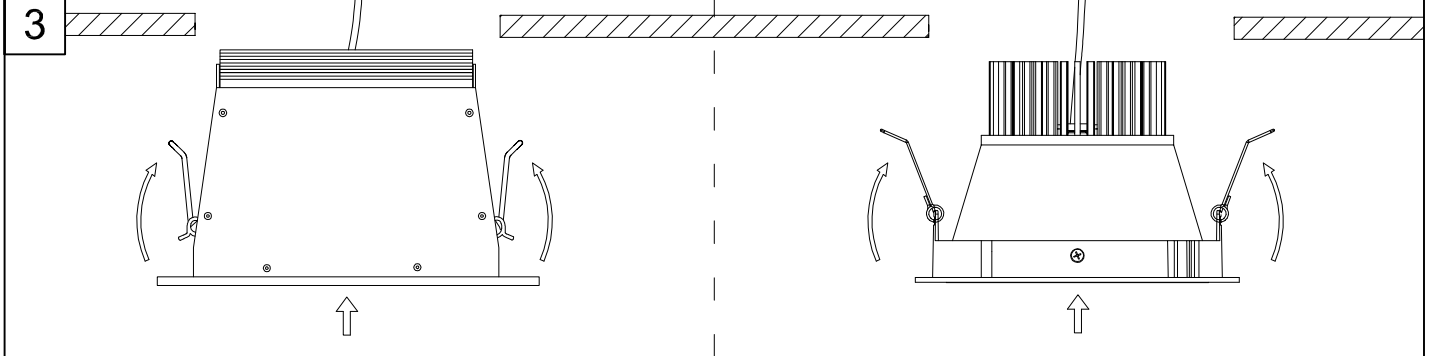

4

