

CARRILES

CR-0324-N3-00

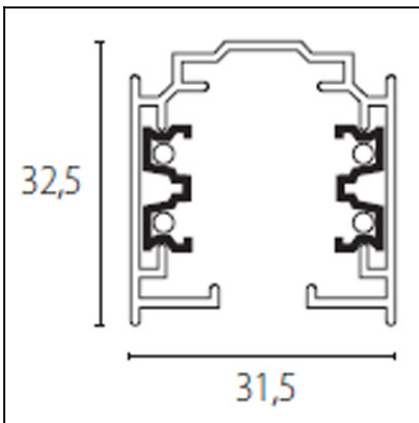

The photograph may not match the reference exactly. Please read the product description to identify the finish.



Download photometric file .ldt /.ies

DESCRIPTION

For recessed mounting

TECHNICAL CHARACTERISTICS

Type:	Accessory
Warranty (Years):	2
Units per box:	12
Net Weight (Kg):	1.71
EAN:	8435111042410,00



MATERIALS / FINISHES

Structure material: Extruded aluminium

Structure finish: Grey

CODE	COLOUR	L(mm)
CR-0323-14-00	White	1000
CR-0323-N3-00	Grey	1000
CR-0323-60-00	Black	1000
CR-0324-14-00	White	2000
CR-0324-N3-00	Grey	2000
CR-0324-60-00	Black	2000
71-3285-14-00	White	3000
71-3285-N3-00	Grey	3000
71-3285-60-00	Black	3000

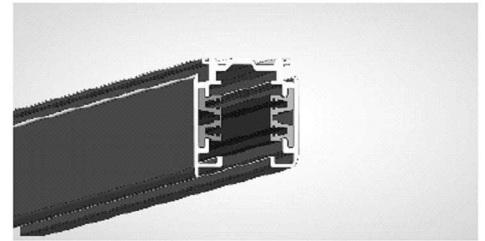

White

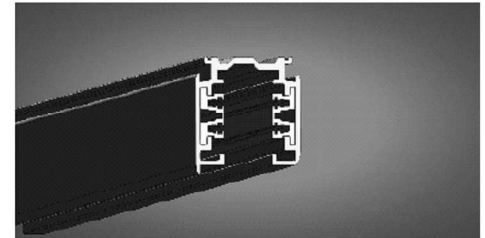

Grey

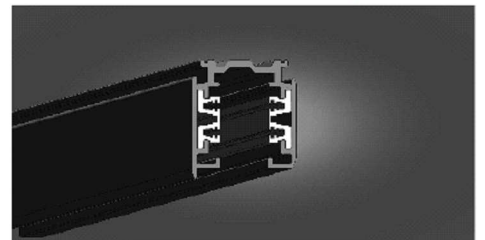

Black

TRACK 1m. 2 FIXATION POINTS

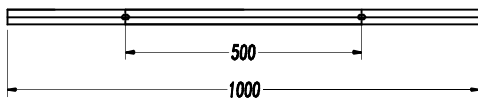

TRACK 2m. 4 FIXATION POINTS

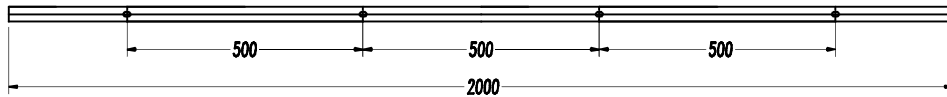

TRACK 3m. 6 FIXATION POINTS

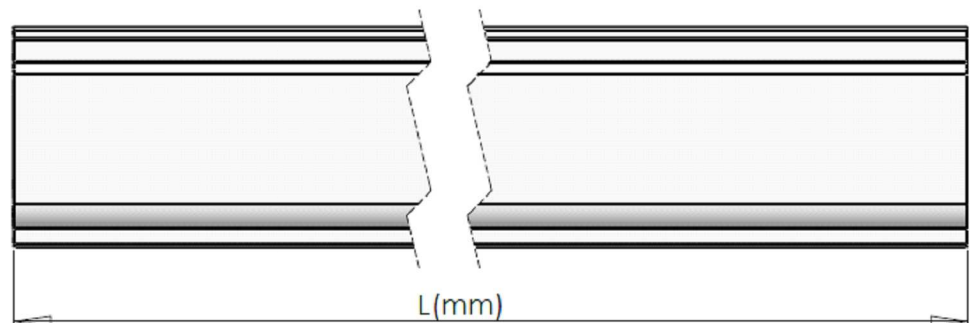
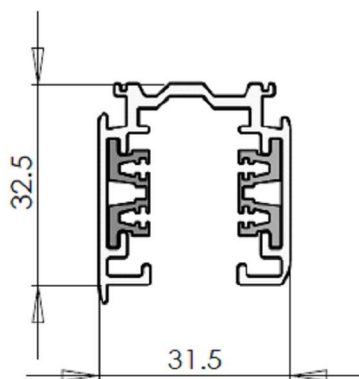
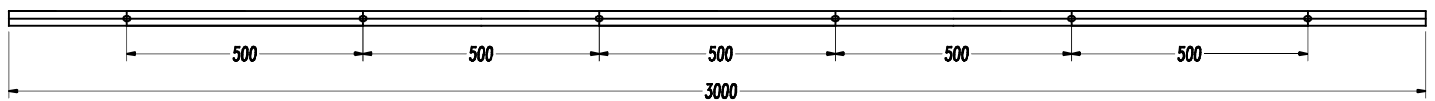

NO

APLICA