

MULTIDIR DM-0056-N3-00

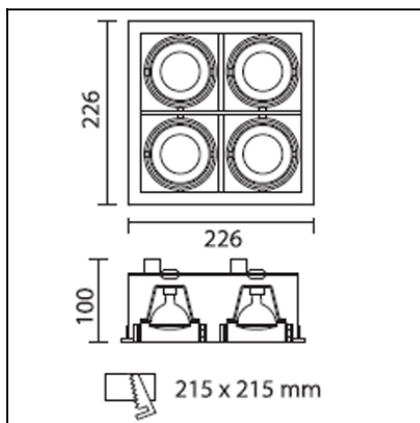

The photograph may not match the reference exactly. Please read the product description to identify the finish.



n° 08
QR-CBC51 50W 60°
 $\eta=100\%$

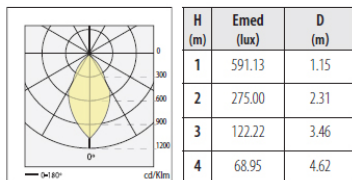

DESCRIPTION

Recessed downlight with steel plate casing and cast aluminium surround, finish in grey or white. Suitable for different numbers of halogen lamps or LED lamps (with the option of including discharge lamps on request). System allowing a wide angle for directing light beam up to 80°. Includes an easily removable cover behind the fitting to allow the installation of different sized lamps. Anchor clips included in the unit can be adjusted without the need for additional tools. With the option of incorporating colour filters.

TECHNICAL CHARACTERISTICS

Type:	Downlight
Adjustable $\pm 40^\circ$ around the two axis forming the horizontal plane.	
IP Protection degrees:	IP23
Lampholder:	4 x GU5.3
Power (W):	GU5.3 50
Voltage / Frequency:	12V/50Hz
Warranty (Years):	2
Units per box:	4
Net Weight (Kg):	1.615
EAN:	8435111037904,00



MATERIALS / FINISHES

Structure material:	Steel Aluminium
Structure finish:	Black lacquered Grey







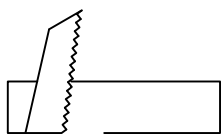
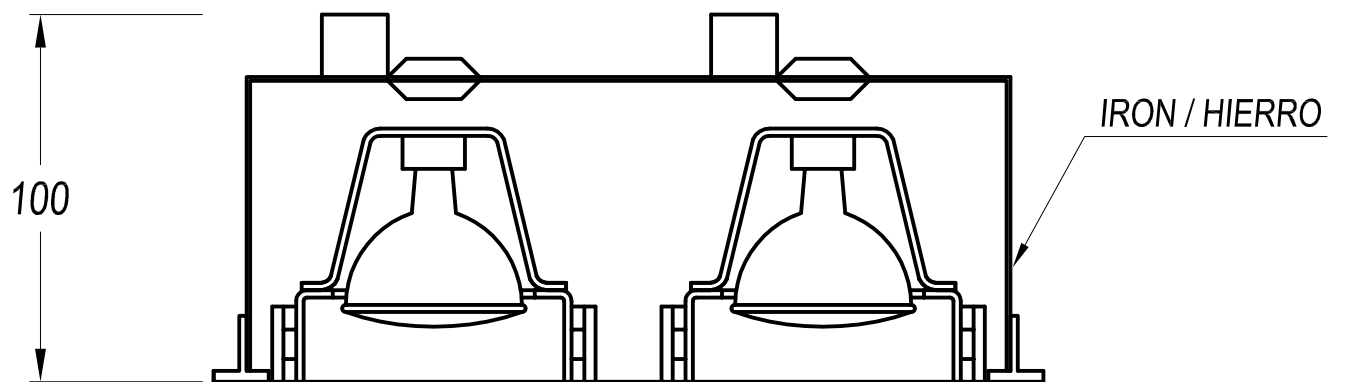
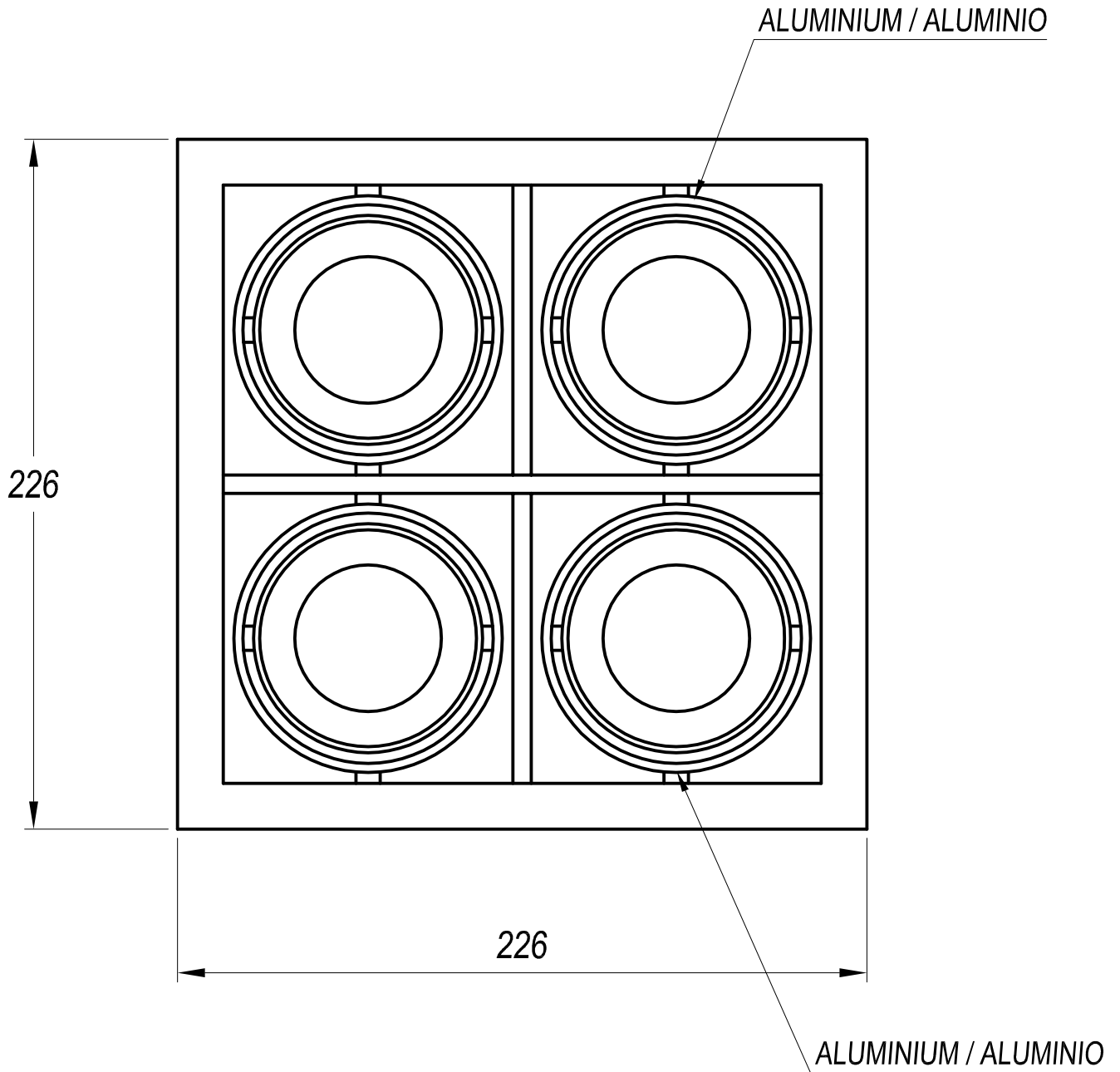











GEAR

Necessary equipment not included. For more information check website / catalogs / sales organization.

Download photometric file .ldt / .ies



215x215

REF.		LAMP	SOCKET		
DM-0053-N3-00	110x110	QR-CBC51 1x50W max.	GU 5.3		
DM-0053-14-00	110x110	QR-CBC51 1x50W max.	GU 5.3		
DM-0054-N3-00	208x110	QR-CBC51 2x50W max.	GU 5.3		
DM-0054-14-00	208x110	QR-CBC51 2x50W max.	GU 5.3		
DM-0055-N3-00	306x110	QR-CBC51 3x50W max.	GU 5.3		
DM-0055-14-00	306x110	QR-CBC51 3x50W max.	GU 5.3		
DM-0056-N3-00	215x215	QR-CBC51 4x50W max.	GU 5.3		
DM-0056-14-00	215x215	QR-CBC51 4x50W max.	GU 5.3		

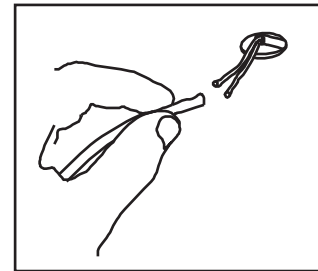
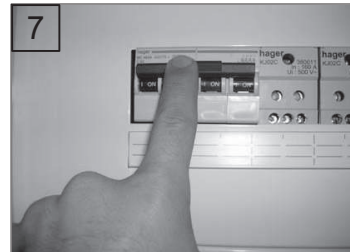
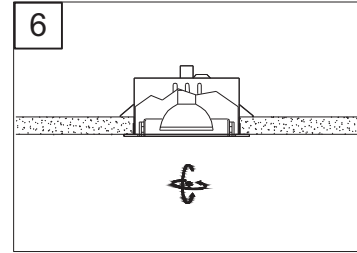
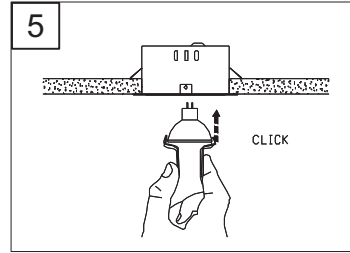
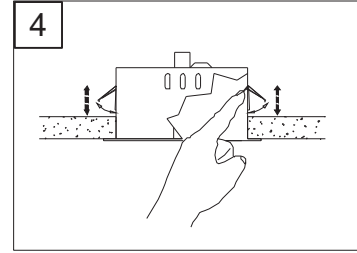
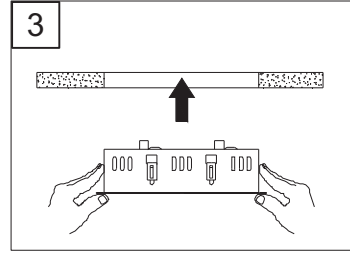
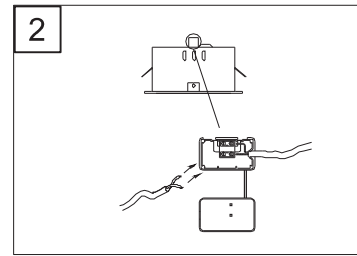
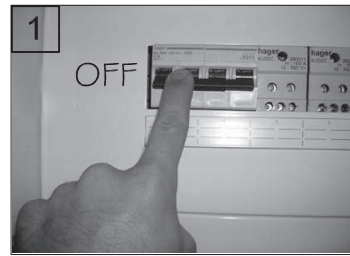

(E) Cubrir toda la longitud del cable de alimentación con los manguitos termicos

(F) Couvrir toute la longueur du cable d'alimentation avec les manchons thermiques fournis avec l'appareil.

(GB) All the length of input wiring should be covered with the insulating sleeves provided with the light fitting.

(D) Zur eitung sk abel alif seiner ganzen lange mit den warmsolisierbuchsen zur auslieferung gelangen. bestucken zusammen mit der leuchte