

MULTIDIR TRIMLESS

DM-0096-60-00

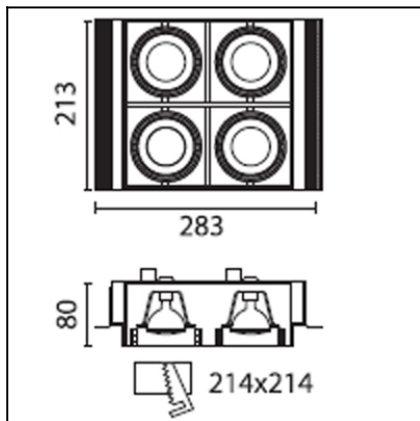

The photograph may not match the reference exactly. Please read the product description to identify the finish.



n° 08
QR-CBC51 50W 60°
η=100 %

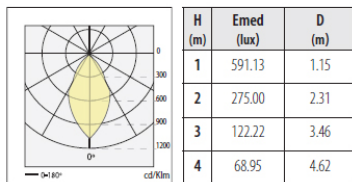

DESCRIPTION

Recessed downlight produced in steel plate. It does not include a surround thus enabling its fully flush installation in the ceiling. Suitable for different numbers of halogen lamps or LED lamps (with the option of including discharge lamps on request). System allowing a wide angle for directing the light beam of up to 80°. Includes an easily removable cover behind the casing to allow the installation of different sized lamps. Anchor clips included in the unit can be adjusted without the need for additional tools. With the option of incorporating colour filters.

TECHNICAL CHARACTERISTICS

Type:	Downlight
Adjustable $\pm 40^\circ$ around the two axis forming the horizontal plane.	
IP Protection degrees:	IP23
Lampholder:	4 x GU5.3
Power (W):	GU5.3 50
Voltage / Frequency:	12V/50Hz
Warranty (Years):	2
Units per box:	4
Net Weight (Kg):	3.06
EAN:	8435111063156,00



MATERIALS / FINISHES

Structure material: Steel
Injected aluminium

Structure finish: Black lacquered
Black

GEAR

Necessary equipment not included. For more information check website / catalogs / sales organization.

Download photometric file .ldt / .ies

IRON / HIERRO

ALUMINIUM / ALUMINIO

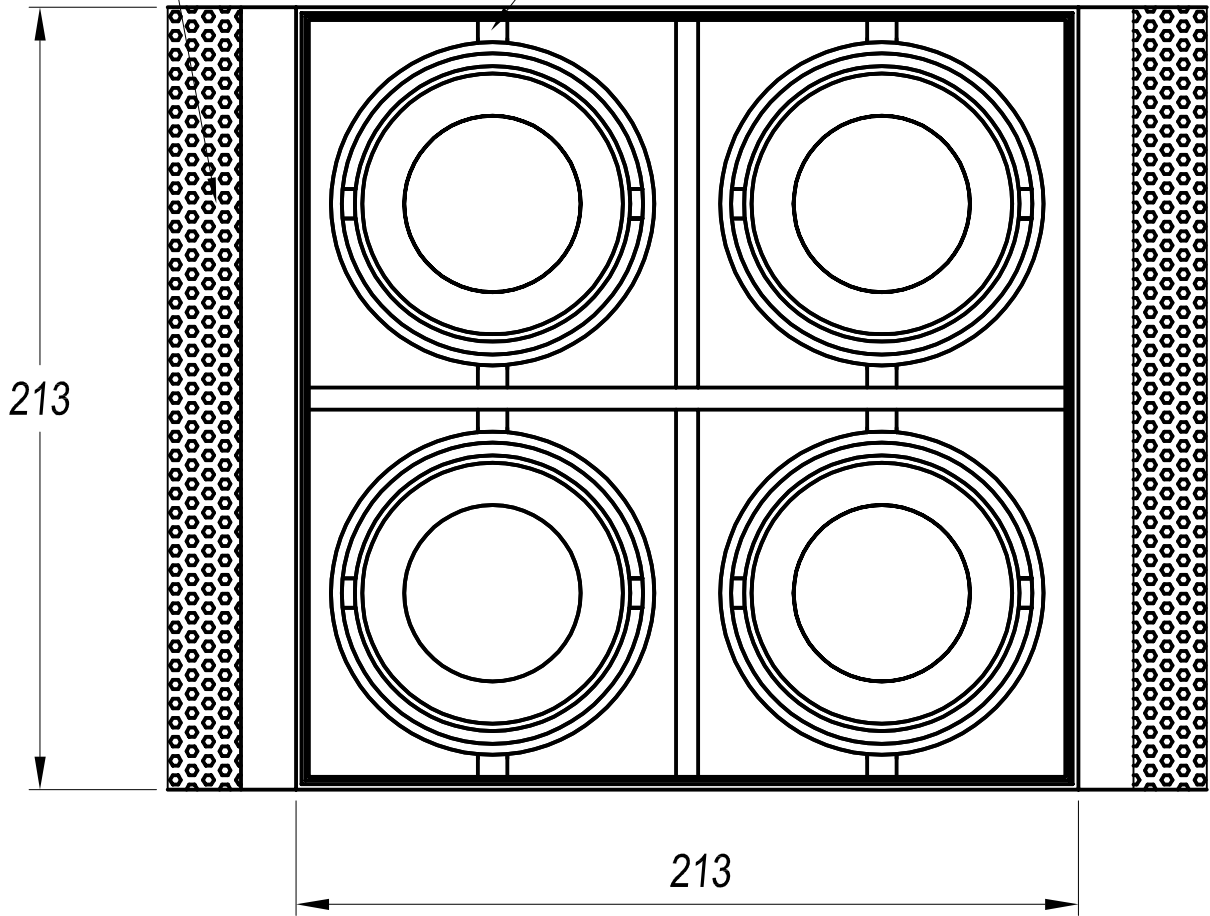

IRON / HIERRO

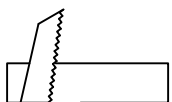
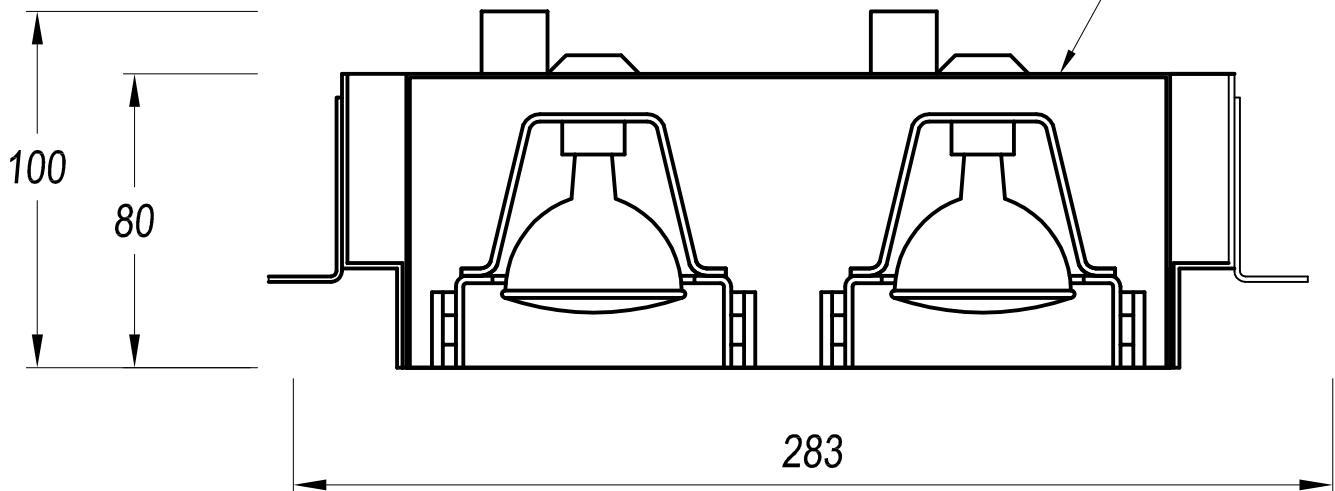

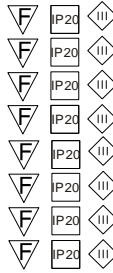

214x214

REF.		LAMP	SOCKET
DM-0081-14-00	156x156	QR-111 1x100W max.	G 53
DM-0081-60-00	156x156	QR-111 1x100W max.	G 53
DM-0082-14-00	300x156	QR-111 2x100W max.	G 53
DM-0082-60-00	300x156	QR-111 2x100W max.	G 53
DM-0083-14-00	444x156	QR-111 3x100W max.	G 53
DM-0083-60-00	444x156	QR-111 3x100W max.	G 53
DM-0084-14-00	311x311	QR-111 4x100W max.	G 53
DM-0084-60-00	311x311	QR-111 4x100W max.	G 53

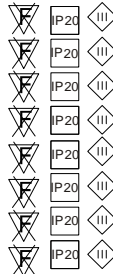

DM-0093-14-00	108x108	QR-CBC51 1x50W max.	GU 5.3
DM-0093-60-00	108x108	QR-CBC51 1x50W max.	GU 5.3
DM-0094-14-00	206x108	QR-CBC51 2x50W max.	GU 5.3
DM-0094-60-00	206x108	QR-CBC51 2x50W max.	GU 5.3
DM-0095-14-00	304x108	QR-CBC51 3x50W max.	GU 5.3
DM-0095-60-00	304x108	QR-CBC51 3x50W max.	GU 5.3
DM-0096-14-00	214x214	QR-CBC51 4x50W max.	GU 5.3
DM-0096-60-00	214x214	QR-CBC51 4x50W max.	GU 5.3



REF.		LAMP	SOCKET
DM-1159-14-00	156x156	AR-111 LED 1x15W	Gu 10
DM-1159-60-00	156x156	AR-111 LED 1x15W	Gu 10
DM-1160-14-00	300x156	AR-111 LED 2x15W	Gu 10
DM-1160-60-00	300x156	AR-111 LED 2x15W	Gu 10
DM-1161-14-00	444x156	AR-111 LED 3x15W	Gu 10
DM-1161-60-00	444x156	AR-111 LED 3x15W	Gu 10
DM-1162-14-00	311x311	AR-111 LED 4x15W	Gu 10
DM-1162-60-00	311x311	AR-111 LED 4x15W	Gu 10

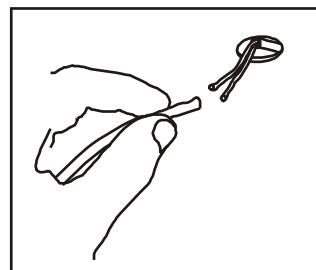
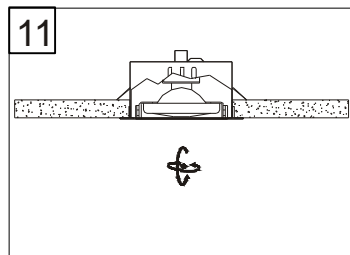
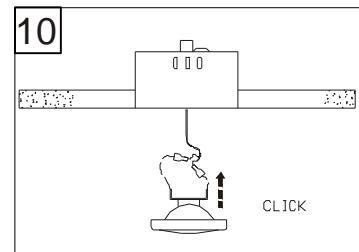
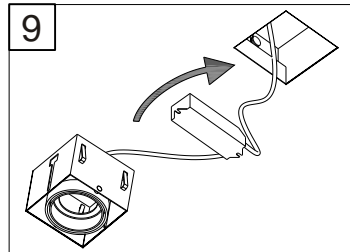
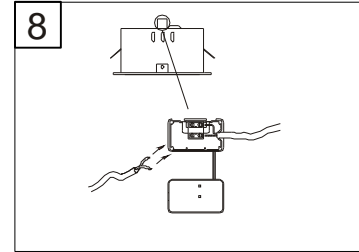
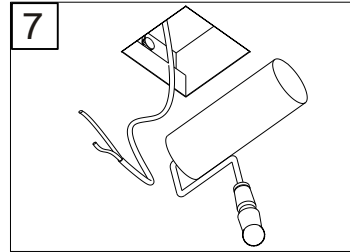
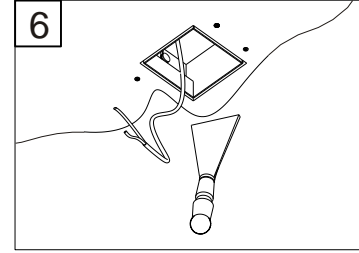
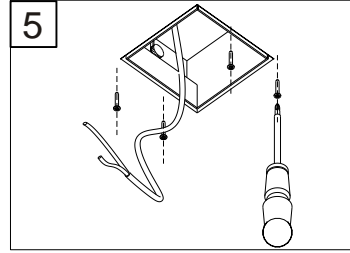
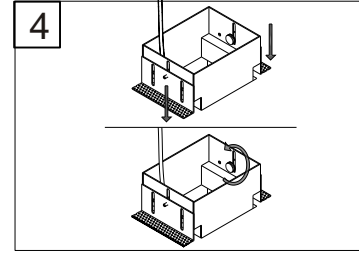
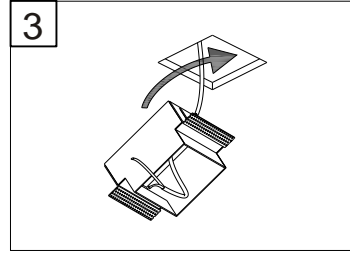
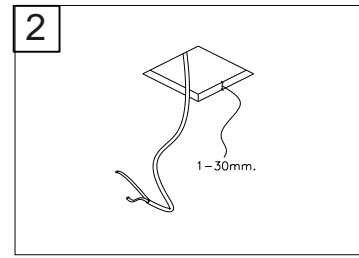
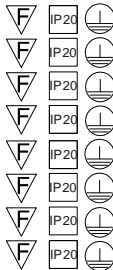

(E) Cubrir toda la longitud del cable de alimentación con los manguitos termicos

(F) Couvrir toute la longueur du cable d'alimentation avec les manchons thermiques fournis avec l'appareil.

(GB) All the length of input wiring should be covered with the insulating sleeves provided with the light fitting.

(D) Zul eitung skabel alif seiner ganzen lange mit den warmisolerbuchsen zurauslieferungslänge zusammen mit der leuchte