

# TRIMIUM MINI DN-0521-S2-00

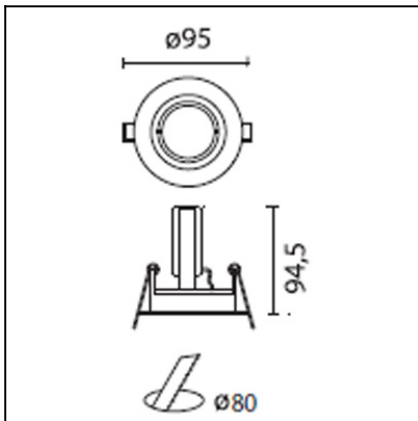

The photograph may not match the reference exactly. Please read the product description to identify the finish.



n° 08  
QR-CBC51 50W 60°  
η=100 %

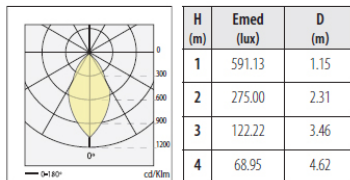

## DESCRIPTION

Small group of recessed downlights. Round body produced in 100% cast aluminium, steel clips and surrounds in different finishes (white, grey and brushed aluminium) in corrosion and rust resistant paint. Suitable for halogen lamps and LED lamps. Various models depending on sizes, angle of direction (two fixed models and two rotating ones) and level of visual comfort. Mounting clips included in the unit can be adjusted without the need for additional tools.

## TECHNICAL CHARACTERISTICS

Type:	Downlight
Adjustable $\pm 20^\circ$ on the horizontal axis.	
IP Protection degrees:	IP23
Lampholder:	1 x GU5.3
Power (W):	GU5.3 50
Voltage / Frequency:	12V/50Hz
Warranty (Years):	2
Units per box:	100
Net Weight (Kg):	0.155
EAN:	8435111057803,00



## MATERIALS / FINISHES

**Structure material:** Aluminium

**Structure finish:** Brushed

## GEAR

Necessary equipment not included. For more information check website / catalogs / sales organization.

Download photometric file .ldt /.ies

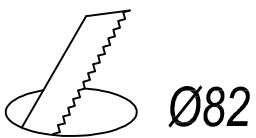
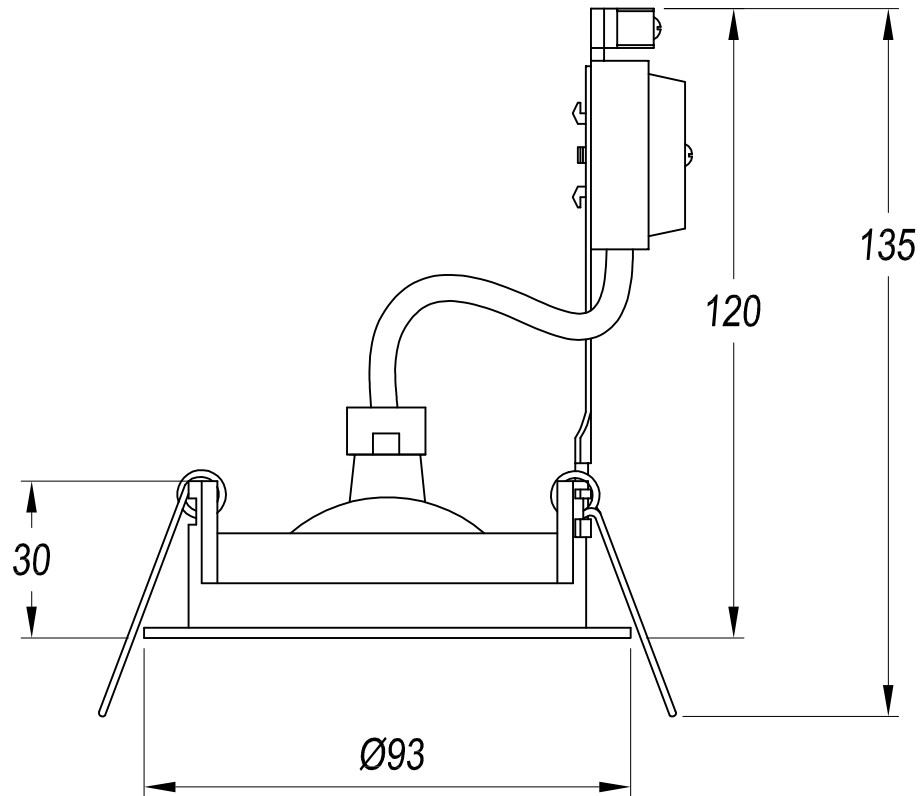
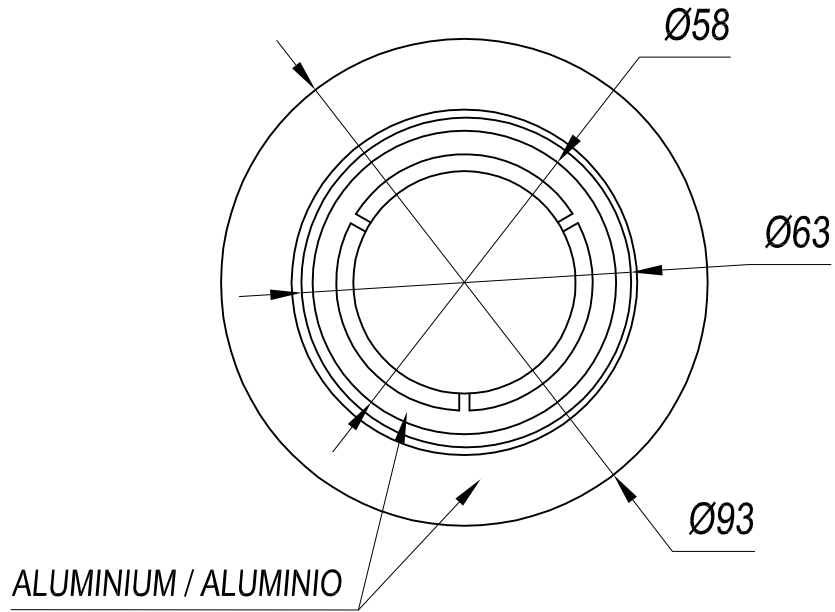

REF.	∅	LAMP	SOCKET
DN-0521-14-00	∅82	QR-CB51 max.50W	GU5.3
DN-0521-52-00	∅82	QR-CB51 max.50W	GU5.3
DN-0521-N3-00	∅82	QR-CB51 max.50W	GU5.3
DN-0521-60-00	∅82	QR-CB51 max.50W	GU5.3

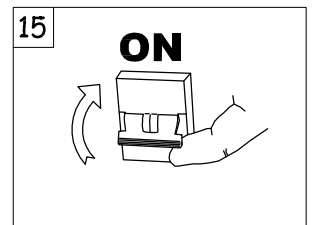
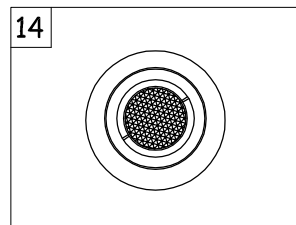
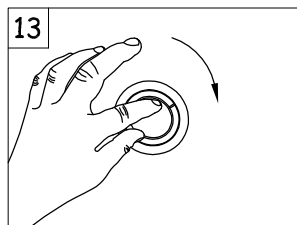
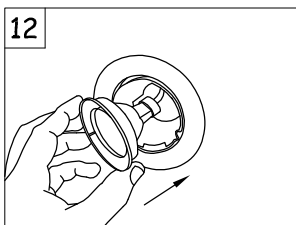
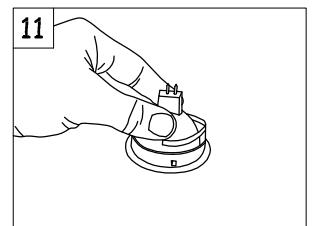
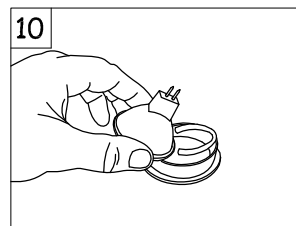
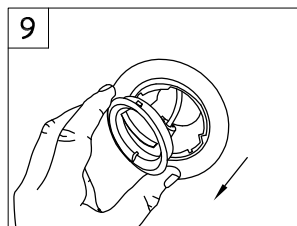
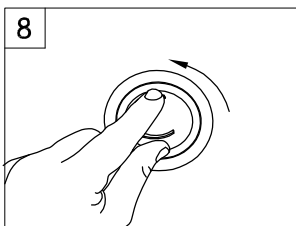
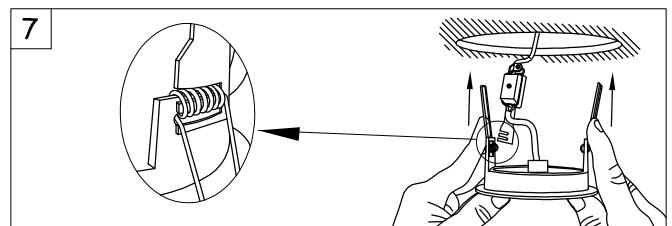
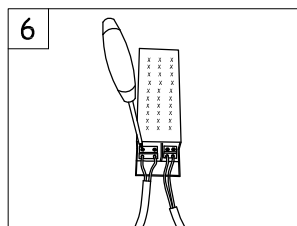
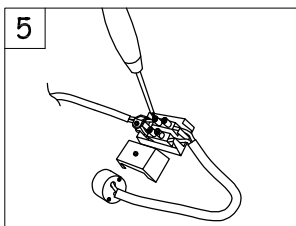
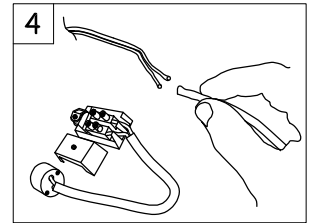
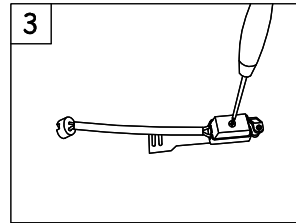
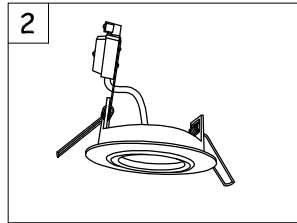
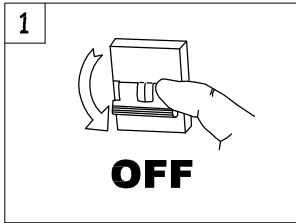
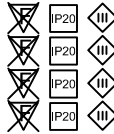

Electronic Transformer  
Transformador electrónico



230 / 240V  
50.....60Hz

