

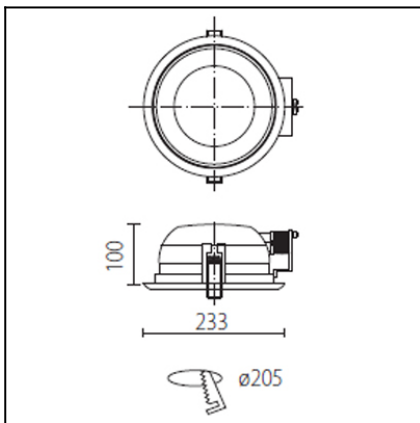

The photograph may not match the reference exactly. Please read the product description to identify the finish.



## DESCRIPTION

Round downlight for flush mounting ballast included. Painted steel plate casing, anodised aluminium reflector and anti-glare glass diffuser. Finished in white or grey. Suitable for compact fluorescent lights. Spring mounting system.

## TECHNICAL CHARACTERISTICS

Type:	Downlight
IP Protection degrees:	IP44
Lampholder:	1 x G24d3
Power (W):	G24d3 26
Voltage / Frequency:	220-240V/50Hz
Warranty (Years):	2
Units per box:	8
Net Weight (Kg):	1.15
EAN:	8435111060087,00



## MATERIALS / FINISHES

**Structure material:** Steel

**Diffuser material:** Tempered glass

**Structure finish:** Baked-on grey paint

**Diffuser finish:** Partly-sandblasted

n° 120  
DN-1402-14-00 1x26W G24d-3  
 $\eta=65,36\%$

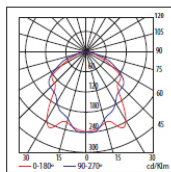

H (m)	Emed (lux)	D (m)
1	105	2.86
2	26	5.72
3	12	8.58
4	7	11.44
5	4	14.30

## GEAR

Gear included: Yes, Magnetic

Download photometric file .ldt / .ies







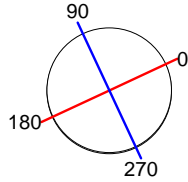
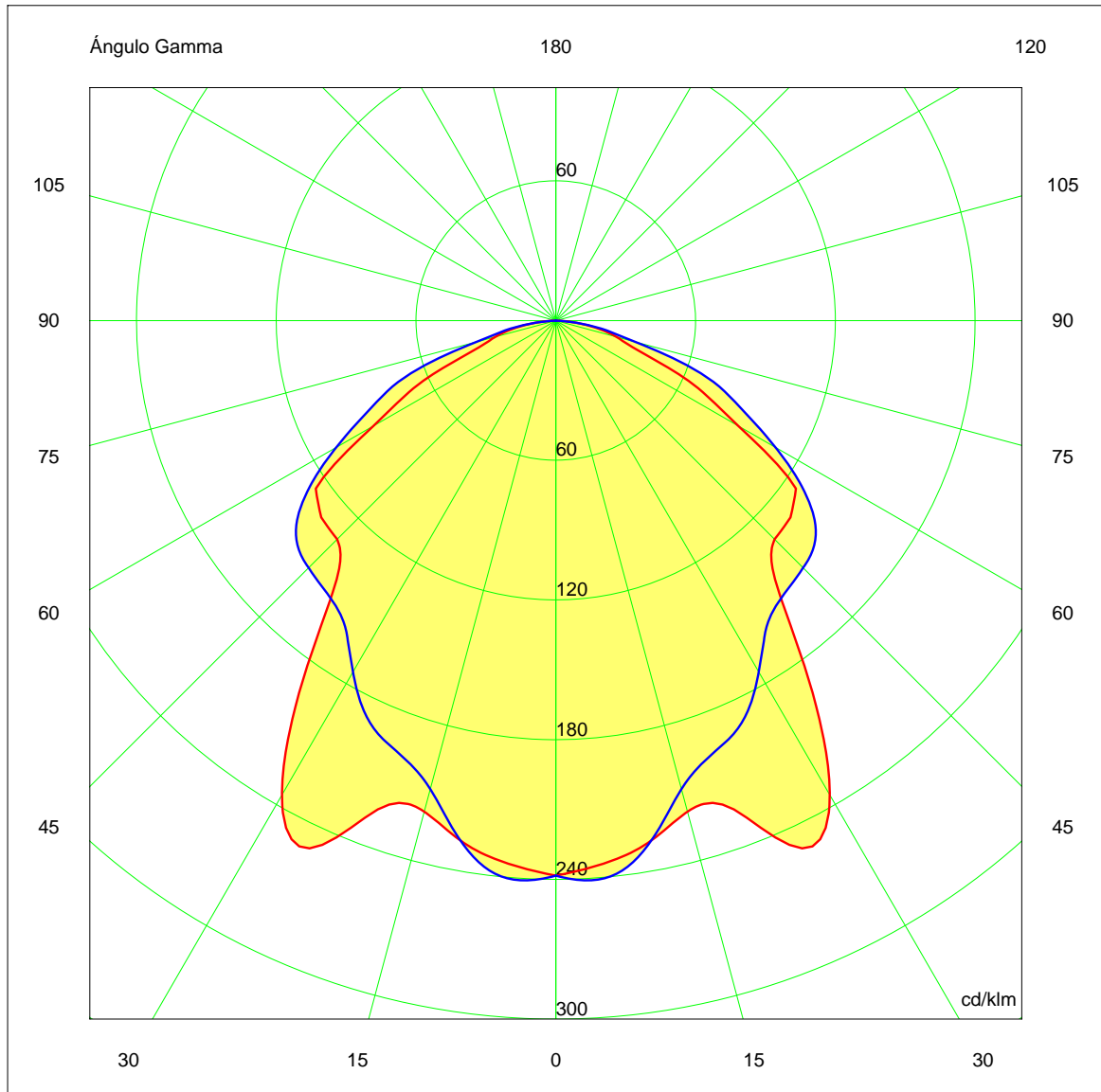

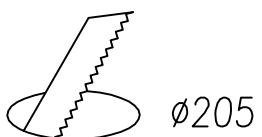
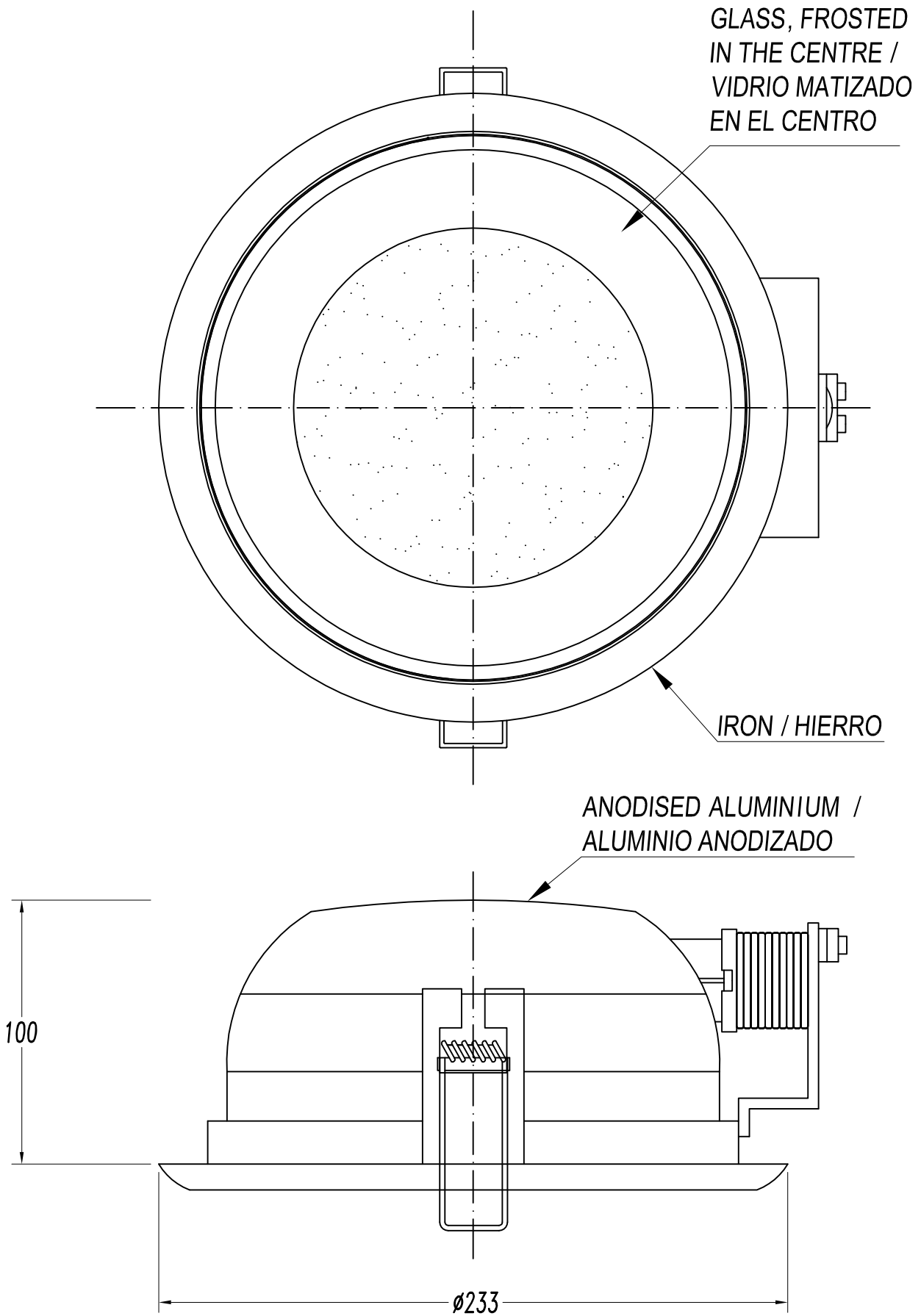







































<b>Luminaria</b>		<b>Ensayo</b>		<b>Lámpara</b>	
Código	DN-1402-14-00	Código	DN-1402-14-00	Código	PLC2684
Nombre	Downlight 1x26W G24d-3	Nombre	Downlight 1x26W G24d-3	Número	1
Familia	- LEDS-C4	Fecha	07-12-2008	Posición	UNIVERSAL
Eficiencia	65.36%	Sist. de Coorden.	C-G	Flujo Total	1800.00 lm
Valor Máximo	250.10 cd/klm	Posición	C=0.00 G=25.00	Bisimétrico	

Diam=223mm Incasso

Semiplanos C

 180.0 ———— 0.0  
 270.0 ———— 90.0



REF.		LAMP	SOCKET			
DN-1400-14-00	∅ 195	TC-D 1x18W	G24d-2			
DN-1401-14-00	∅ 195	TC-D 2x18W	G24d-2			
DN-1402-14-00	∅ 195	TC-D 1x26W	G24d-3			
DN-1403-14-00	∅ 195	TC-D 2x26W	G24d-3			
DN-1405-14-00	∅ 195	TC-DEL 1x18W	G24q-2			
DN-1406-14-00	∅ 195	TC-DEL 2x18W	G24q-2			
DN-1407-14-00	∅ 195	TC-DEL 1x26W	G24q-3			
DN-1408-14-00	∅ 195	TC-DEL 2x26W	G24q-3			
DN-1400-N3-00	∅ 195	TC-D 1x18W	G24d-2			
DN-1401-N3-00	∅ 195	TC-D 2x18W	G24d-2			
DN-1402-N3-00	∅ 195	TC-D 1x26W	G24d-3			
DN-1403-N3-00	∅ 195	TC-D 2x26W	G24d-3			
DN-1405-N3-00	∅ 195	TC-DEL 1x18W	G24q-2			
DN-1406-N3-00	∅ 195	TC-DEL 2x18W	G24q-2			
DN-1407-N3-00	∅ 195	TC-DEL 1x26W	G24q-3			
DN-1408-N3-00	∅ 195	TC-DEL 2x26W	G24q-3	