

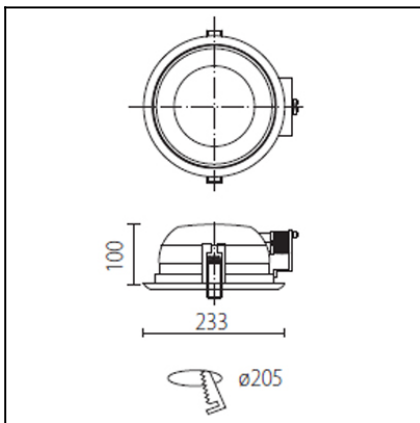

The photograph may not match the reference exactly. Please read the product description to identify the finish.



DESCRIPTION

Round downlight for flush mounting ballast included. Painted steel plate casing, anodised aluminium reflector and anti-glare glass diffuser. Finished in white or grey. Suitable for compact fluorescent lights. Spring mounting system.

TECHNICAL CHARACTERISTICS

Type:	Downlight
IP Protection degrees:	IP44
Lampholder:	2 x G24d3
Power (W):	G24d3 26
Voltage / Frequency:	220-240V/50Hz
Warranty (Years):	2
Units per box:	8
Net Weight (Kg):	1.685
EAN:	8435111059647,00



MATERIALS / FINISHES

Structure material: Steel
Structure finish: White

Diffuser material: Tempered glass
Diffuser finish: Partly-sandblasted

n° 121
 DN-1403-14-00 2x26W G24d-3
 $\eta=47,49\%$

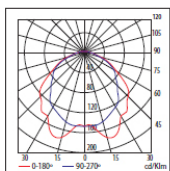

H (m)	Emed (lux)	D (m)
1	198	2.85
2	50	5.69
3	22	8.54
4	12	11.38
5	8	14.23

GEAR

Gear included: Yes, Magnetic

Download photometric file .ldt / .ies

Luminaria		Ensayo		Lámpara	
Código	DN-1403-14-00	Código	DN-1403-14-00	Código	PLC2684
Nombre	Downlight 2x26W G24d-3	Nombre	Downlight 2x26W G24d-3	Número	2
Familia	- LEDS-C4	Fecha	07-12-2008	Posición	UNIVERSAL
Eficiencia	47.49%	Sist. de Coorden.	C-G	Flujo Total	3600.00 lm
Valor Máximo	175.01 cd/klm	Posición	C=0.00 G=20.00	Bisimétrico	

Diam=223mm Incasso



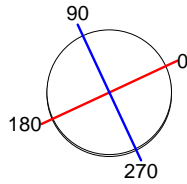



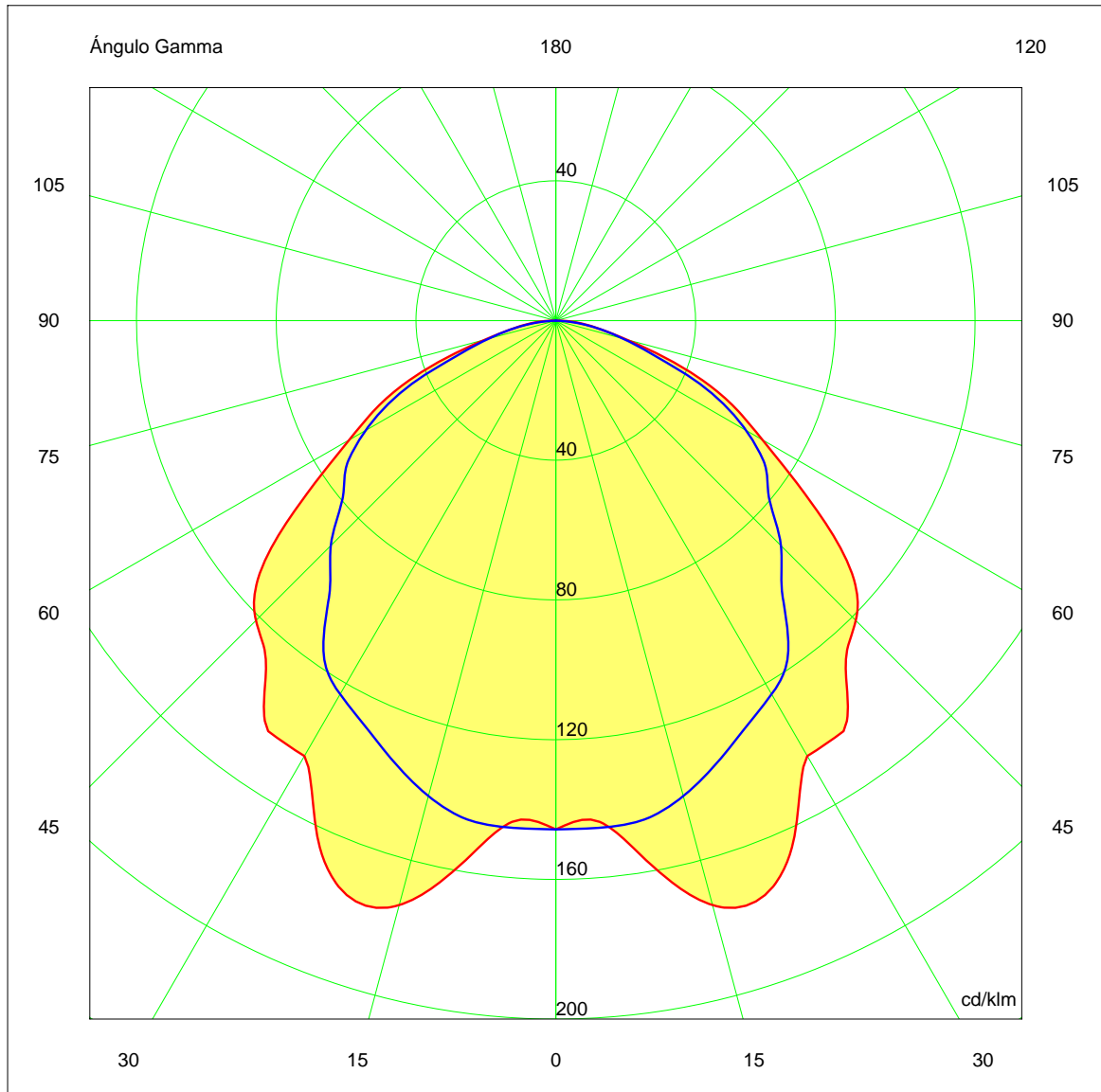

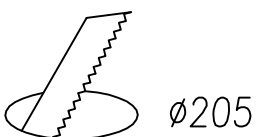
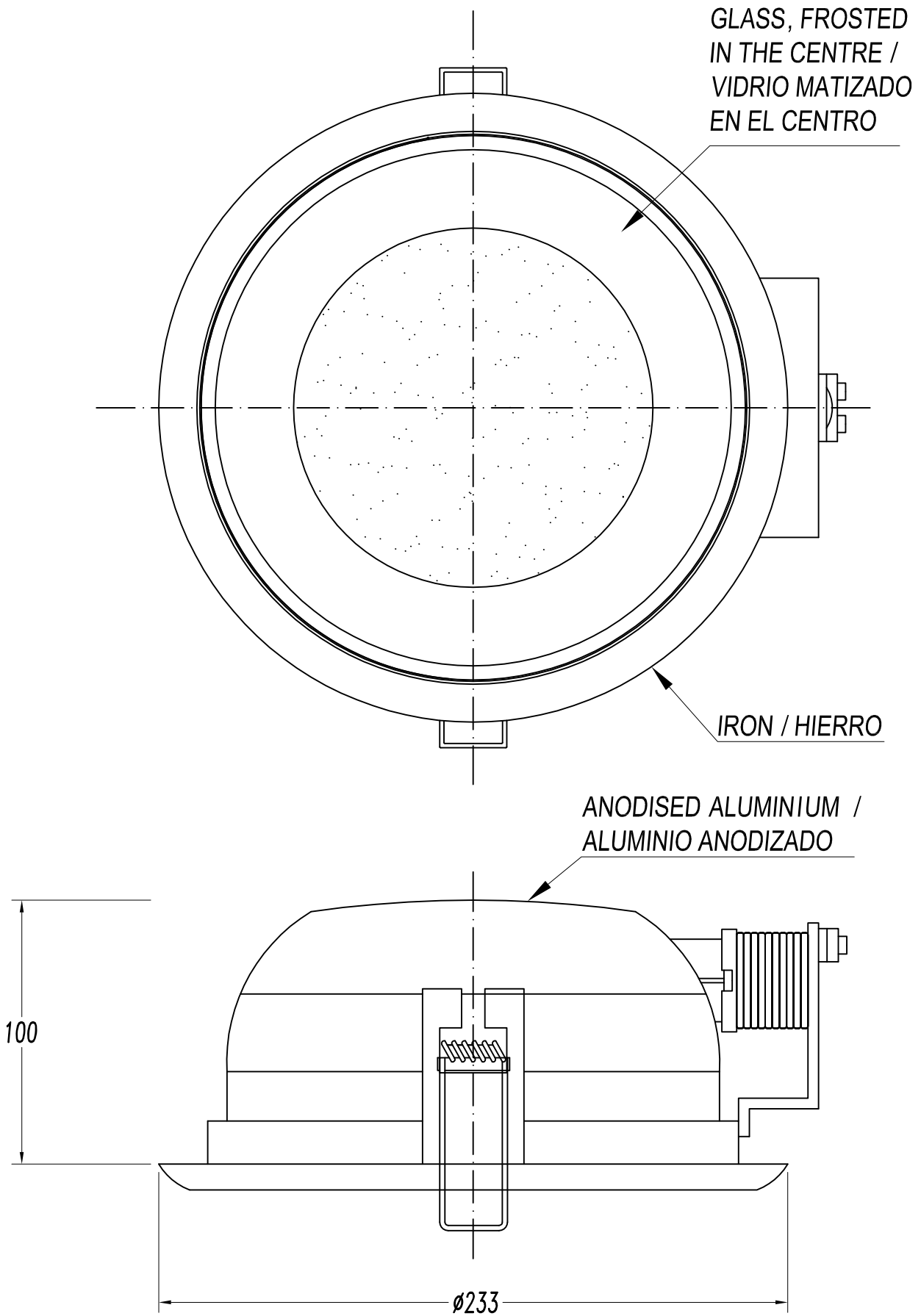







































Semiplanos C



180.0 ——— 0.0
 270.0 ——— 90.0





REF.		LAMP	SOCKET			
DN-1400-14-00	Ø 195	TC-D 1x18W	G24d-2			
DN-1401-14-00	Ø 195	TC-D 2x18W	G24d-2			
DN-1402-14-00	Ø 195	TC-D 1x26W	G24d-3			
DN-1403-14-00	Ø 195	TC-D 2x26W	G24d-3			
DN-1405-14-00	Ø 195	TC-DEL 1x18W	G24q-2			
DN-1406-14-00	Ø 195	TC-DEL 2x18W	G24q-2			
DN-1407-14-00	Ø 195	TC-DEL 1x26W	G24q-3			
DN-1408-14-00	Ø 195	TC-DEL 2x26W	G24q-3			
DN-1400-N3-00	Ø 195	TC-D 1x18W	G24d-2			
DN-1401-N3-00	Ø 195	TC-D 2x18W	G24d-2			
DN-1402-N3-00	Ø 195	TC-D 1x26W	G24d-3			
DN-1403-N3-00	Ø 195	TC-D 2x26W	G24d-3			
DN-1405-N3-00	Ø 195	TC-DEL 1x18W	G24q-2			
DN-1406-N3-00	Ø 195	TC-DEL 2x18W	G24q-2			
DN-1407-N3-00	Ø 195	TC-DEL 1x26W	G24q-3			
DN-1408-N3-00	Ø 195	TC-DEL 2x26W	G24q-3	