

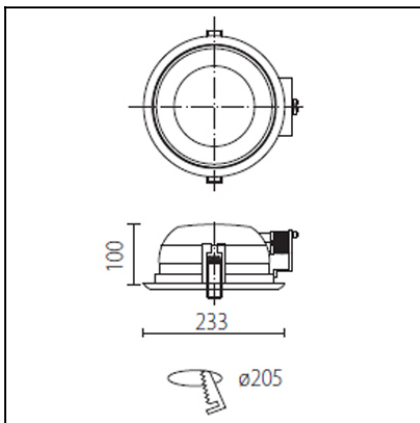

The photograph may not match the reference exactly. Please read the product description to identify the finish.



DESCRIPTION

Round downlight for flush mounting ballast included. Painted steel plate casing, anodised aluminium reflector and anti-glare glass diffuser. Finished in white or grey. Suitable for compact fluorescent lights. Spring mounting system.

TECHNICAL CHARACTERISTICS

Type:	Downlight
IP Protection degrees:	IP44
Lampholder:	2 x G24q2
Power (W):	G24q2 18
Voltage / Frequency:	230V/50-60Hz
Warranty (Years):	2
Units per box:	8
Net Weight (Kg):	0.835
EAN:	8435111060117,00



MATERIALS / FINISHES

Structure material: Steel
Structure finish: Epoxy finish

Diffuser material: Tempered glass
Diffuser finish: Tinted

GEAR

Gear included: Yes, electronic

n° 122
DN-1406-14-00 ECO 2x18W G24q-2 dif. opal
 $\eta=60,87\%$

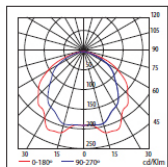

H (m)	Emed (lux)	D (m)
1	138	3,49
2	34	6,97
3	15	10,46
4	9	13,94
5	6	17,43

Download photometric file .ldt / .ies

Luminaria		Ensayo		Lámpara	
Código	DN-1401-14-00	Código	DN-1401-14-00	Código	PLC1884
Nombre	Downlight ECO 2x18W TC-D opal	Nombre	Downlight ECO 2x18W TC-D	Número	2
Familia	- LEDS-C4	Fecha	04-12-2008	Posición	Universal
Eficiencia	54.75%	Sist. de Coord.	C-G	Flujo Total	2400.00 lm
Valor Máximo	202.72 cd/klm	Posición	C=0.00 G=25.00		Bisimétrico

Diam=225mm Incasso



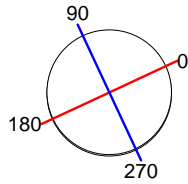



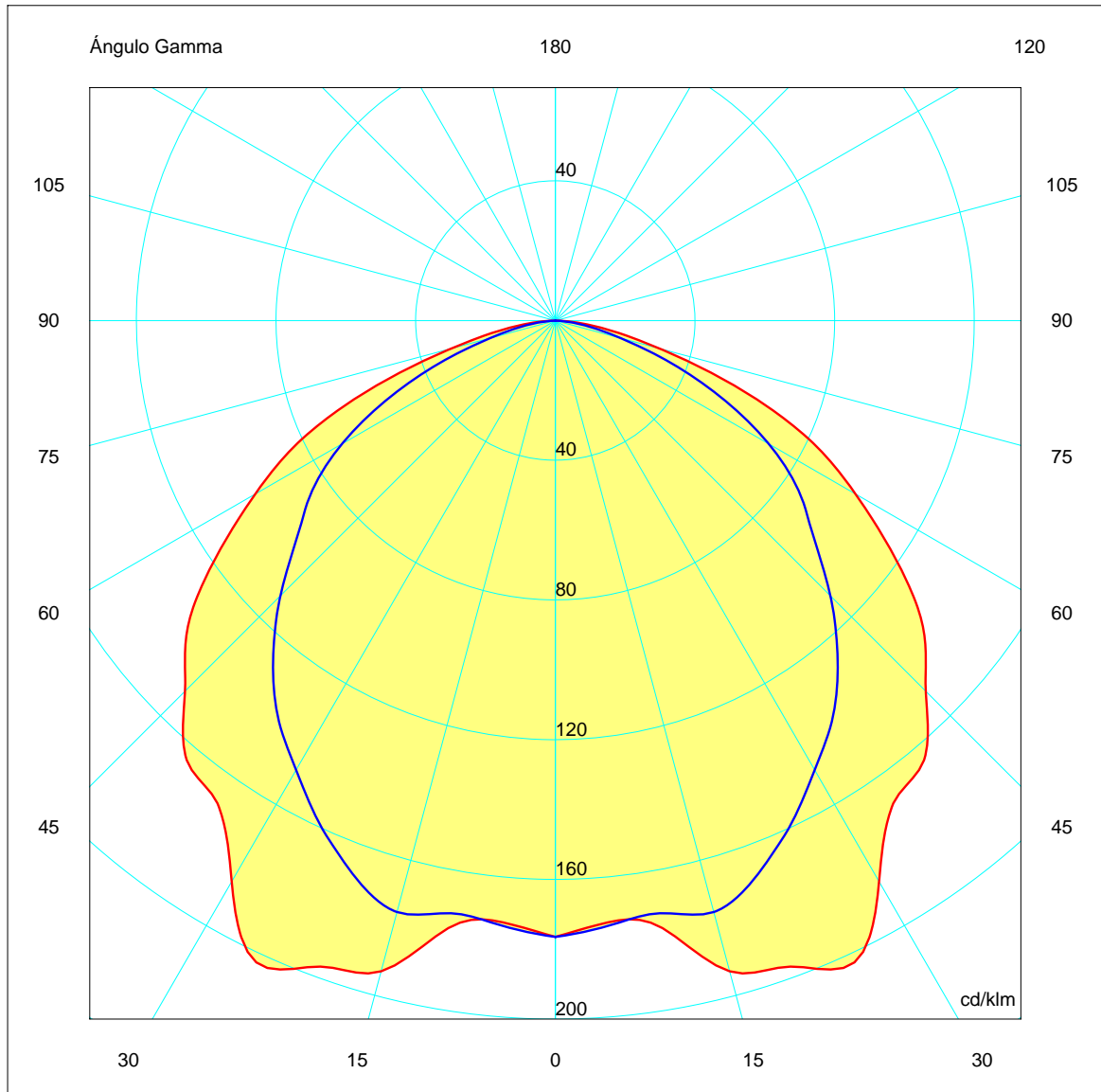

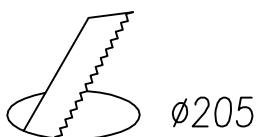
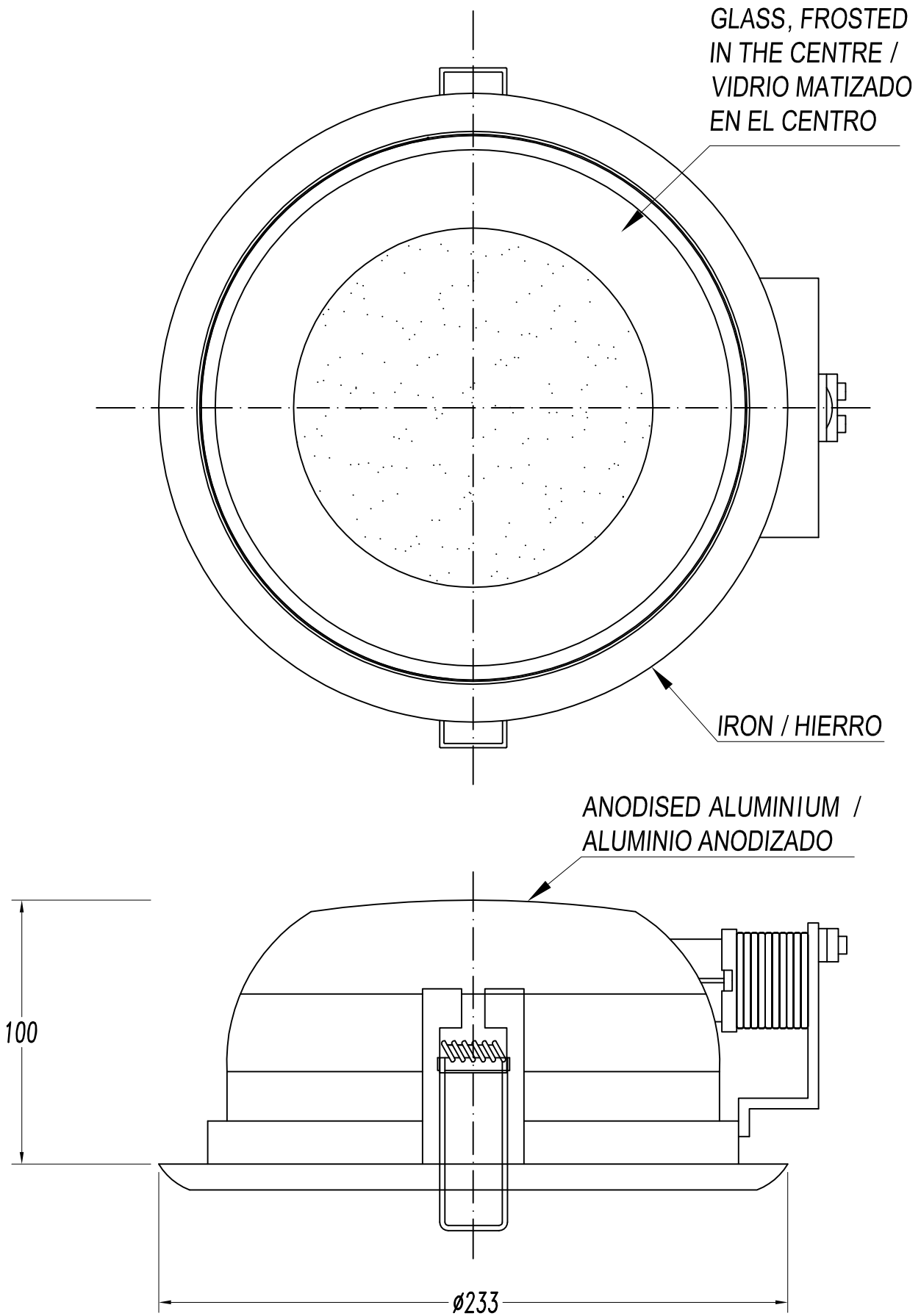





































Semiplanos C



180.0 ——— 0.0
270.0 ——— 90.0





REF.		LAMP	SOCKET			
DN-1400-14-00	∅ 195	TC-D 1x18W	G24d-2			
DN-1401-14-00	∅ 195	TC-D 2x18W	G24d-2			
DN-1402-14-00	∅ 195	TC-D 1x26W	G24d-3			
DN-1403-14-00	∅ 195	TC-D 2x26W	G24d-3			
DN-1405-14-00	∅ 195	TC-DEL 1x18W	G24q-2			
DN-1406-14-00	∅ 195	TC-DEL 2x18W	G24q-2			
DN-1407-14-00	∅ 195	TC-DEL 1x26W	G24q-3			
DN-1408-14-00	∅ 195	TC-DEL 2x26W	G24q-3			
DN-1400-N3-00	∅ 195	TC-D 1x18W	G24d-2			
DN-1401-N3-00	∅ 195	TC-D 2x18W	G24d-2			
DN-1402-N3-00	∅ 195	TC-D 1x26W	G24d-3			
DN-1403-N3-00	∅ 195	TC-D 2x26W	G24d-3			
DN-1405-N3-00	∅ 195	TC-DEL 1x18W	G24q-2			
DN-1406-N3-00	∅ 195	TC-DEL 2x18W	G24q-2			
DN-1407-N3-00	∅ 195	TC-DEL 1x26W	G24q-3			
DN-1408-N3-00	∅ 195	TC-DEL 2x26W	G24q-3	