

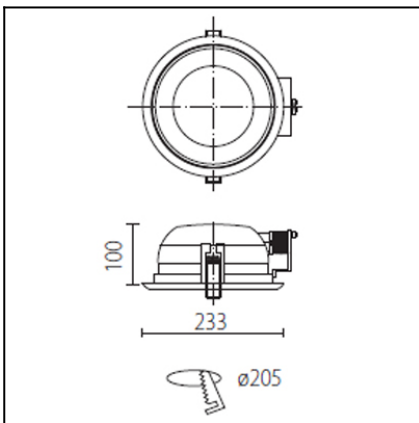

The photograph may not match the reference exactly. Please read the product description to identify the finish.



## DESCRIPTION

Round downlight for flush mounting ballast included. Painted steel plate casing, anodised aluminium reflector and anti-glare glass diffuser. Finished in white or grey. Suitable for compact fluorescent lights. Spring mounting system.

## TECHNICAL CHARACTERISTICS

Type:	Downlight
IP Protection degrees:	IP44
Lampholder:	1 x G24q3
Power (W):	G24q3 26
Voltage / Frequency:	230V/50-60Hz
Warranty (Years):	2
Units per box:	1
Net Weight (Kg):	0.795
EAN:	8435111060148,00



## MATERIALS / FINISHES

**Structure material:** Steel

**Diffuser material:** Tempered glass

**Structure finish:** Baked-on grey paint

**Diffuser finish:** Partly-sandblasted

n° 123

DN-1407-14-00 ECO.1x26W G24q-2 dif. opal

$\eta=69,05\%$

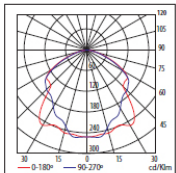

H (m)	Emed (lux)	D (m)
1	91	3.42
2	23	6.84
3	10	10.26
4	6	13.69
5	4	17.11

## GEAR

Gear included: Yes, electronic

Download photometric file .ldt / .ies

<b>Luminaria</b>		<b>Ensayo</b>		<b>Lámpara</b>	
Código	DN-1402-14-00	Código	DN-1402-14-00	Código	PLC2684
Nombre	Downlight 1x26W G24d-3	Nombre	Downlight 1x26W G24d-3	Número	1
Familia	- LEDS-C4	Fecha	07-12-2008	Posición	UNIVERSAL
Eficiencia	65.36%	Sist. de Coorden.	C-G	Flujo Total	1800.00 lm
Valor Máximo	250.10 cd/klm	Posición	C=0.00 G=25.00	Bisimétrico	

Diam=223mm Incasso



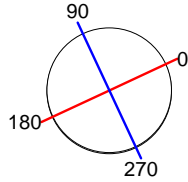



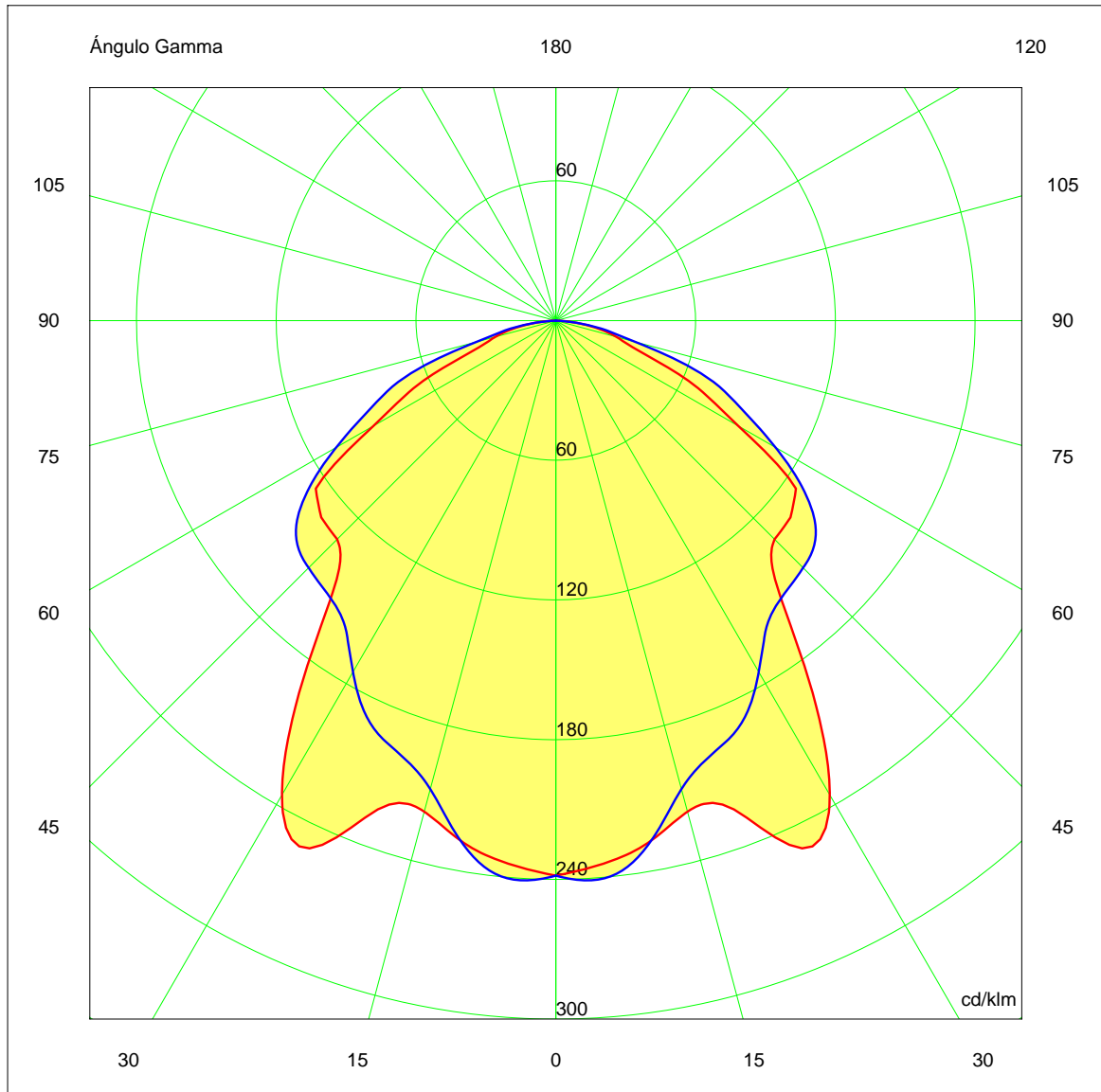

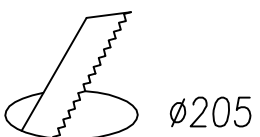
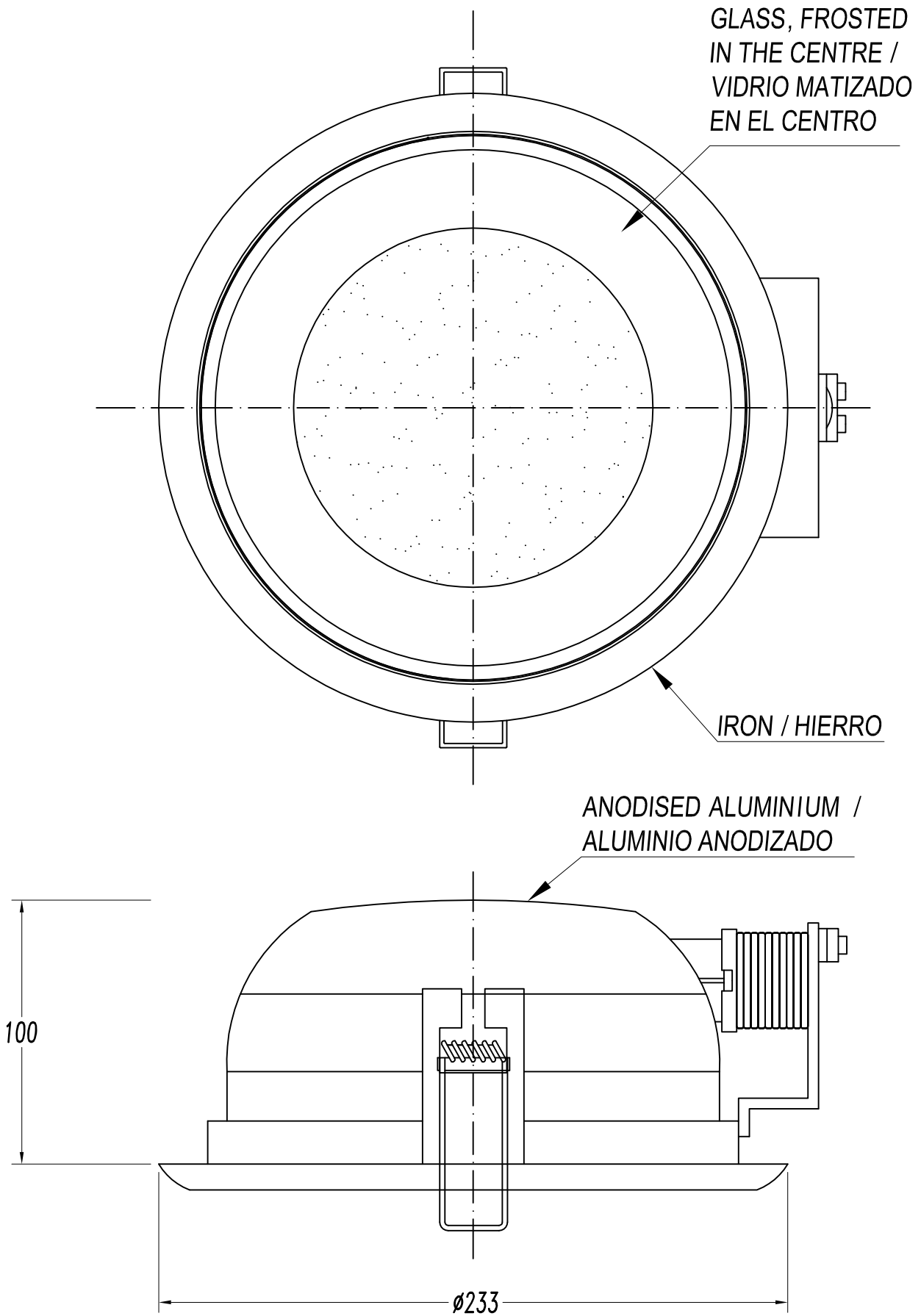







































Semiplanos C



180.0 ——— 0.0  
 270.0 ——— 90.0





REF.		LAMP	SOCKET			
DN-1400-14-00	∅ 195	TC-D 1x18W	G24d-2			
DN-1401-14-00	∅ 195	TC-D 2x18W	G24d-2			
DN-1402-14-00	∅ 195	TC-D 1x26W	G24d-3			
DN-1403-14-00	∅ 195	TC-D 2x26W	G24d-3			
DN-1405-14-00	∅ 195	TC-DEL 1x18W	G24q-2			
DN-1406-14-00	∅ 195	TC-DEL 2x18W	G24q-2			
DN-1407-14-00	∅ 195	TC-DEL 1x26W	G24q-3			
DN-1408-14-00	∅ 195	TC-DEL 2x26W	G24q-3			
DN-1400-N3-00	∅ 195	TC-D 1x18W	G24d-2			
DN-1401-N3-00	∅ 195	TC-D 2x18W	G24d-2			
DN-1402-N3-00	∅ 195	TC-D 1x26W	G24d-3			
DN-1403-N3-00	∅ 195	TC-D 2x26W	G24d-3			
DN-1405-N3-00	∅ 195	TC-DEL 1x18W	G24q-2			
DN-1406-N3-00	∅ 195	TC-DEL 2x18W	G24q-2			
DN-1407-N3-00	∅ 195	TC-DEL 1x26W	G24q-3			
DN-1408-N3-00	∅ 195	TC-DEL 2x26W	G24q-3	