

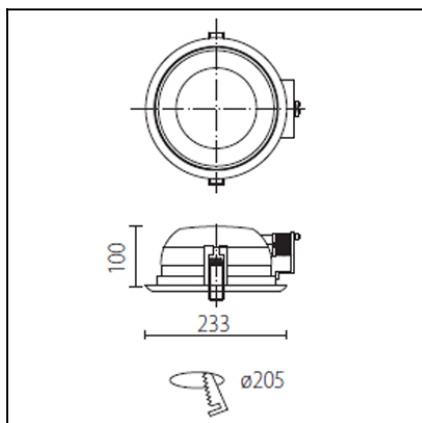

The photograph may not match the reference exactly. Please read the product description to identify the finish.



DESCRIPTION

Round downlight for flush mounting ballast included. Painted steel plate casing, anodised aluminium reflector and anti-glare glass diffuser. Finished in white or grey. Suitable for compact fluorescent lights. Spring mounting system.

TECHNICAL CHARACTERISTICS

Type:	Downlight
IP Protection degrees:	IP44
Lampholder:	2 x G24q3
Power (W):	G24q3 26
Voltage / Frequency:	230V/50-60Hz
Warranty (Years):	2
Units per box:	1
Net Weight (Kg):	0.845
EAN:	8435111060162,00



MATERIALS / FINISHES

Structure material: Steel

Diffuser material: Tempered glass

Structure finish: Baked-on grey paint

Diffuser finish: Partly-sandblasted

n° 124

DN-1408-14-00 2x26W G24q-3

$\eta=53,15\%$

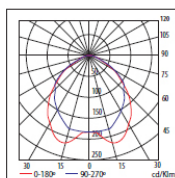









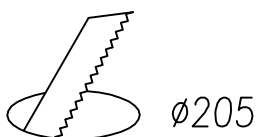
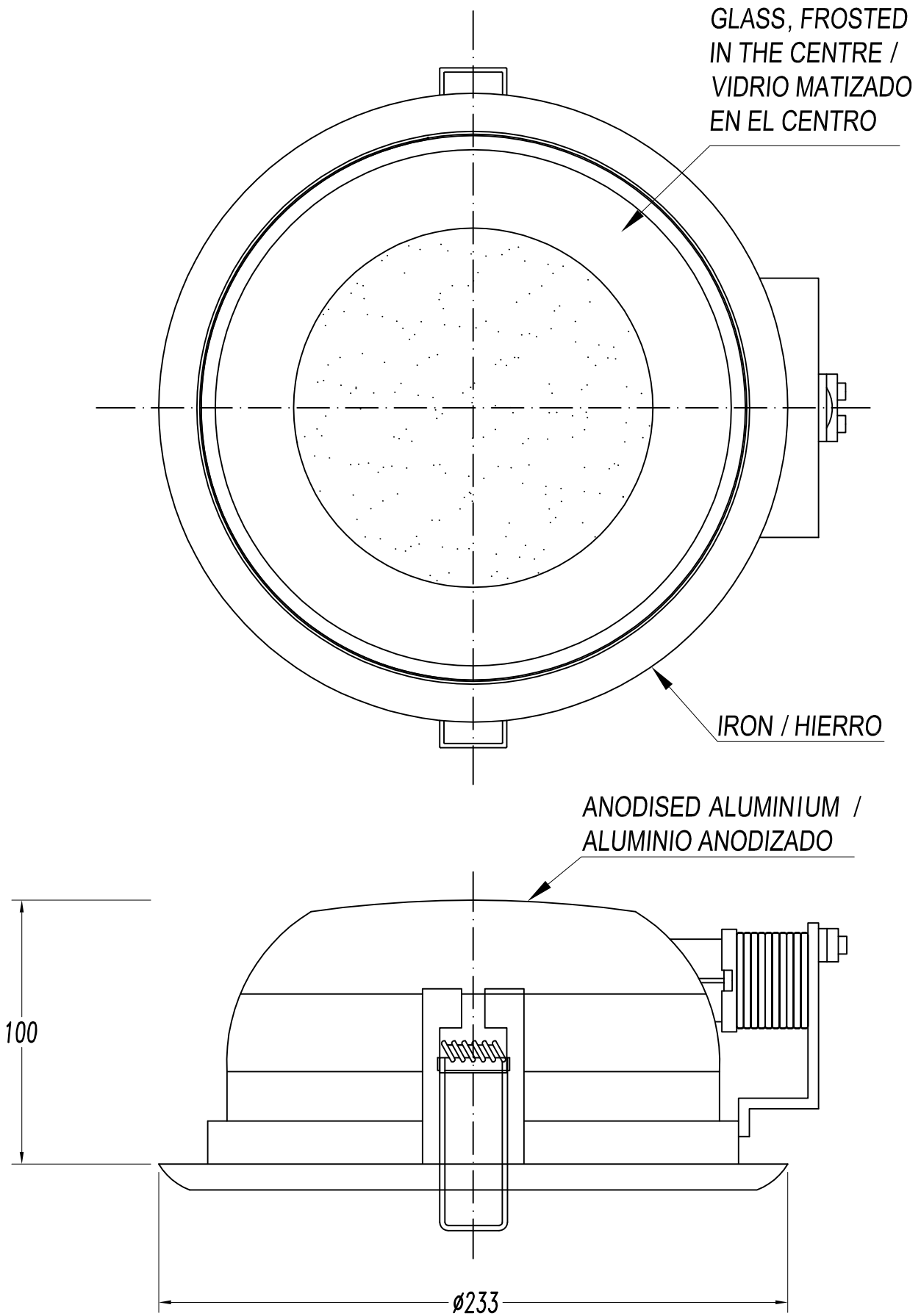



























H (m)	Emed (lux)	D (m)
1	255	2.32
2	64	4.65
3	28	6.97
4	16	9.29
5	10	11.62

GEAR

Gear included: Yes, electronic

Download photometric file .ldt / .ies



REF.		LAMP	SOCKET			
DN-1400-14-00	Ø 195	TC-D 1x18W	G24d-2		IP44	
DN-1401-14-00	Ø 195	TC-D 2x18W	G24d-2		IP44	
DN-1402-14-00	Ø 195	TC-D 1x26W	G24d-3		IP44	
DN-1403-14-00	Ø 195	TC-D 2x26W	G24d-3		IP44	
DN-1405-14-00	Ø 195	TC-DEL 1x18W	G24q-2		IP44	
DN-1406-14-00	Ø 195	TC-DEL 2x18W	G24q-2		IP44	
DN-1407-14-00	Ø 195	TC-DEL 1x26W	G24q-3		IP44	
DN-1408-14-00	Ø 195	TC-DEL 2x26W	G24q-3		IP44	
DN-1400-N3-00	Ø 195	TC-D 1x18W	G24d-2		IP44	
DN-1401-N3-00	Ø 195	TC-D 2x18W	G24d-2		IP44	
DN-1402-N3-00	Ø 195	TC-D 1x26W	G24d-3		IP44	
DN-1403-N3-00	Ø 195	TC-D 2x26W	G24d-3		IP44	
DN-1405-N3-00	Ø 195	TC-DEL 1x18W	G24q-2		IP44	
DN-1406-N3-00	Ø 195	TC-DEL 2x18W	G24q-2		IP44	
DN-1407-N3-00	Ø 195	TC-DEL 1x26W	G24q-3		IP44	
DN-1408-N3-00	Ø 195	TC-DEL 2x26W	G24q-3		IP44	